

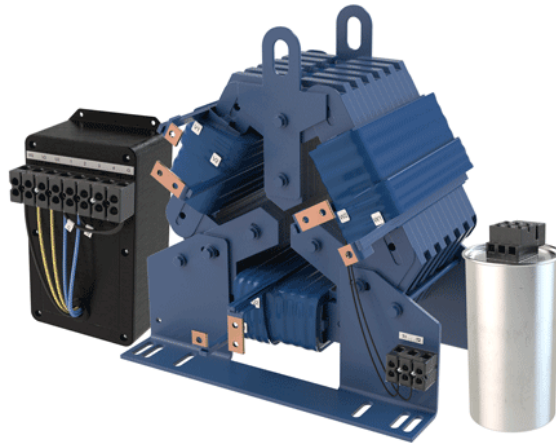

SineWave Nexus™

380V – 600V

TECHNICAL REFERENCE MANUAL



High Voltage! Only a qualified electrician can carry out the electrical installation of this filter.

Quick Reference

1	Performance Data	Pages 5 - 10
2	Selection Guide	Pages 11 – 16
3	Installation Guide	Pages 17 – 28
4	Start-up/Troubleshooting	Pages 29 – 33

This page intentionally left blank

TABLE OF CONTENTS

1. SAFETY	1
WARNINGS AND CAUTIONS.....	1
GENERAL SAFETY INSTRUCTIONS.....	2
2. GENERAL INFORMATION	3
RECEIPT & REPAIR STATEMENT	3
ENCLOSURES	4
AGENCY APPROVALS	4
WARRANTY.....	4
3. SINEWAVE NEXUS PERFORMANCE DATA	5
PERFORMANCE SPECIFICATIONS	5
FILTER EFFICIENCY + WATT LOSS, SINEWAVE NEXUS 380-480V	6
FILTER EFFICIENCY + WATT LOSS, SINEWAVE NEXUS 600V	7
VOLTAGE WAVEFORMS	8
COMMON MODE VOLTAGE WAVEFORMS.....	9
ALTITUDE DERATING.....	10
MOTOR FREQUENCY DERATING	10
4. HOW TO SELECT	11
SELECTION GUIDE	11
UNDERSTANDING THE SINEWAVE NEXUS PART NUMBER	12
SINEWAVE NEXUS 380-480V, 60HZ SELECTION TABLES	13
SINEWAVE NEXUS 600V, 60HZ SELECTION TABLES	15
5. HOW TO INSTALL	17
INSTALLATION CHECKLIST	17
POWER WIRING CONNECTION	19
COMMON MODE ASSEMBLY CONNECTION	20
MODULAR UNIT INTERCONNECTION DIAGRAM	22
ENCLOSED UNIT INTERCONNECTION DIAGRAM.....	23
BASIC SCHEMATIC DIAGRAM	24
TRANSFORMER DIAGRAM.....	25
COMMON MODE ASSEMBLY CONNECTION DIAGRAMS	26
TORQUE RATINGS 380-480V	27
TORQUE RATINGS 600V	28
6. START-UP	29
SAFETY PRECAUTIONS.....	29
7. TROUBLESHOOTING	31

List of Figures

Figure 3-1: Output Voltage before SineWave Nexus	8
Figure 3-2: Output Voltage after SineWave Nexus	8
Figure 3-3: Common Mode Voltage without SineWave Nexus	9
Figure 3-4: Common Mode Voltage with SineWave Nexus	9
Figure 3-5: Altitude Derating Curve	10
Figure 3-6: Motor Frequency Derating	10
Figure 5-1: Modular Interconnection	22
Figure 5-2: Enclosed Interconnection	23
Figure 5-3: Basic Schematic Diagram	24
Figure 5-4: Transformer Diagram	25
Figure 5-5: DC Bus Connected Configuration	26
Figure 5-6: Ground Connected Configuration	26



List of Tables

Table 3-1: Performance Specifications	5
Table 3-2: Filter Efficiency + Watt Loss SineWave Nexus 380-480V, 60Hz	6
Table 3-3: Filter Efficiency + Watt Loss SineWave Nexus 600V, 60Hz	7
Table 4-1: SineWave Nexus 380-480V Open Panel	13
Table 4-2: SineWave Nexus 380-480V Enclosed NEMA 1/2	14
Table 4-3: SineWave Nexus 380-480V Enclosed NEMA 3R	14
Table 4-4: SineWave Nexus 600V Open Panel	15
Table 4-5: SineWave Nexus 600V Enclosed NEMA 1/2	16
Table 4-6: SineWave Nexus 600V Enclosed NEMA 3R	16
Table 5-1: Overtemperature Switch	18
Table 5-2: Torque Ratings 380-480V	27
Table 5-3: Torque Ratings 600V	28
Table 7-1: Troubleshooting Guide	32



1. SAFETY

Warnings and Cautions

The following symbols are used in this manual:

 WARNING	High Voltage Warning: warns of situations that dangerously high voltage is involved. Failure to use proper precautions may lead to serious injury or death.
 WARNING	General Warning: warns of situations that can result in serious injury or death if proper precautions are not used.
 Caution	General Caution: identifies situations that could lead to malfunction or possible equipment damage.

General Safety Instructions

 WARNING	<p>High Voltage! Only a qualified electrician can carry out the electrical installation of this filter.</p>
	<p>High voltage is used in the operation of this filter. Use extreme caution to avoid contact with high voltage when operating, installing or repairing this filter. Injury or death may result if safety precautions are not observed.</p>
 WARNING	<p>The opening of the branch circuit protective device may be an indication that a fault current has been interrupted. To reduce the risk of fire or electrical shock, current-carrying parts and other components of the filter should be examined and replaced if damaged.</p>
	<p>An upstream disconnect/protection device must be used as required by the National Electrical Code (NEC) or governing authority.</p>
	<p>Even if the upstream disconnect/protection device is open, the drive downstream of the filter may feed back high voltage to the filter. The drive safety instructions must be followed. Injury or death may result if safety precautions are not observed.</p>
	<p>The filter must be grounded with a grounding conductor connected to all grounding terminals. Modular filters must have reactor grounded through a 2"x2" area cleaned of paint and varnish on lower mounting bracket.</p>
	<p>Only spare parts obtained from MTE Corporation or an authorized MTE distributor can be used.</p>
	<p>After removing power, allow at least five minutes to elapse and verify that the capacitors have discharged to a safe level before contacting internal components. Connect a DC voltmeter across the capacitor terminals and ensure that the voltage is at a safe level.</p>
 Caution	<p>Loose or improperly secured connections may damage or degrade filter performance. Visually inspect and secure all electrical connections before power is applied to the filter.</p>
	<p>Prior to start-up; confirm the drive operation mode is properly set (Volts per Hertz). Please consult drive manual/manufacturer to configure proper parameters. Failure to do so may result in failure of drive or filter components.</p>

2. GENERAL INFORMATION

The purpose of this manual is to properly specify, size, and install the SineWave Nexus.

For most current information, please refer to website:

<http://www.mtecorp.com/nexus-sinewave-filter/>

SineWave Nexus filters transform the output of Variable Frequency Drives (VFDs) to a near perfect sinusoidal waveform for the best level of motor protection. MTE's unique design offers high performance in both differential and common mode with smaller size and better efficiency than traditional industry solutions.

Receipt & Repair Statement

Upon Receipt of this Filter:

The SineWave Nexus motor protection filter has been subjected to demanding factory tests before shipment. Carefully inspect the shipping container for damage that may have occurred in transit. Then unpack the filter and carefully inspect for any signs of damage. Save the shipping container for future transport of the filter.

In the event of damage, please contact and file a claim with the freight carrier involved immediately.

If the equipment is not going to be put into service upon receipt, cover and store the filter in a clean, dry location. After storage, ensure that the equipment is dry and that no condensation or dirt has accumulated on the internal components of the filter before applying power.

Repair/Exchange Procedure

MTE Corporation requires a Return Material Authorization Number and form before we can accept any filters that qualify for return or repair. If problems or questions arise during installation, setup, or operation of the filter, please contact MTE for assistance at:

Toll Free: 1-800-455-4MTE (1-800-455-4683)

International Tel: (+1) 262-253-8200

Fax: 262-253-8222

Enclosures

MTE enclosures are designed to provide a degree of protection for electrical components and prevent incidental personnel contact with the enclosed equipment. Depending on the enclosure selected, these enclosures meet the requirements of NEMA 1/2 or NEMA 3R.

An approximate cross reference guide between NEMA, UL, CSA and IEC enclosure follows.

Type 1 NEMA / IEC IP20 Enclosure:

Are designed for indoor use and will provide protection against contact with the enclosed equipment.

Type 2 NEMA / IEC IP20 Enclosure:

Are designed for indoor use and will provide protection against contact with the enclosed equipment and provide a degree of protection against limited amounts of falling water and dirt.

Type 3R NEMA / IEC IP21 Enclosure:

Are designed for outdoor use primarily to provide protection against contact with the enclosed equipment and provide a degree of protection against falling rain sleet and external ice formation.

Agency Approvals

UL and cUL listed to UL508 Type MX and CSA-C22.2 No 14-95
File E180243

Warranty

Three years from the date of shipment. See <http://www.mtecorp.com/industry-leading-warranty/> for details.

3. SineWave Nexus Performance Data

Performance Specifications

Table 3-1: Performance Specifications

Service Load Condition	Conventional 3 phase motors operating in volts per Hertz mode Standard step-up or delta-wye transformer
Voltage	380-480V +/- 10%
	600V +/- 10%
Input Voltage Wave Form	PWM
Harmonic Voltage Distortion	5% maximum @ 4kHz
Common Mode Attenuation	-20dB (>90% PWM common mode RMS voltage reduction) @ 4-8kHz
Inverter Switching Frequency	2kHz – 8kHz (Optimal performance achieved @ 4kHz)
Inverter Operating Frequency	6Hz to 75Hz, >75Hz to 120Hz with derating
Maximum Ambient Temperature	-40C to +60C Modular Filter -40C to +55C Enclosed Filter -40C to +90C Storage
Insulation System	Class N (200° C)
Insertion Loss (Voltage)	10% maximum @ 60Hz
Efficiency	>98%
Current range	2A – 160A
Available form factors	Modular NEMA 1/2 NEMA 3R
Altitude without derating	3,300 feet above sea level*
Maximum Motor Lead Length	15,000 feet
Relative Humidity	0% to 95% non-condensing
Current Rating	100% RMS Continuous 150% for 1 minute Intermittent
Audible Noise	75dBA at 1 meter

NOTE: Filter does not mitigate any DC bus ripple that may be present, or 3rd order harmonics injected by the drive.

*See Figure 3-5: Altitude Derating Curve (p10)

Filter Efficiency + Watt loss, SineWave Nexus 380-480V

Table 3-2: Filter Efficiency + Watt Loss SineWave Nexus 380-480V, 60Hz

Maximum Output Amps RMS/Filter Current Rating Amps RMS	Efficiency (%)	Typical Power Dissipation (Watts*)
2	98.40%	33
3	98.50%	36
5	98.60%	55
12	98.90%	102
17	98.90%	148
22	98.90%	180
27	99.00%	207
45	99.20%	296
65	99.10%	457
110	99.35%	559
130	99.30%	729
160	99.40%	760

*Based on a typical 480V, 60Hz output frequency, 2kHz carrier frequency at full load application.

Filter Efficiency + Watt loss, SineWave Nexus 600V

Table 3-3: Filter Efficiency + Watt Loss SineWave Nexus 600V, 60Hz

Maximum Output Amps RMS/Filter Current Rating Amps RMS	Efficiency (%)	Typical Power Dissipation (Watts*)
5	98.50%	76
12	98.70%	157
17	98.70%	213
22	98.90%	243
27	99.00%	268
45	99.00%	458
65	99.30%	467
110	99.20%	910
130	99.30%	930

*Based on a typical 600V, 60Hz output frequency, 2kHz carrier frequency at full load application.

Voltage Waveforms

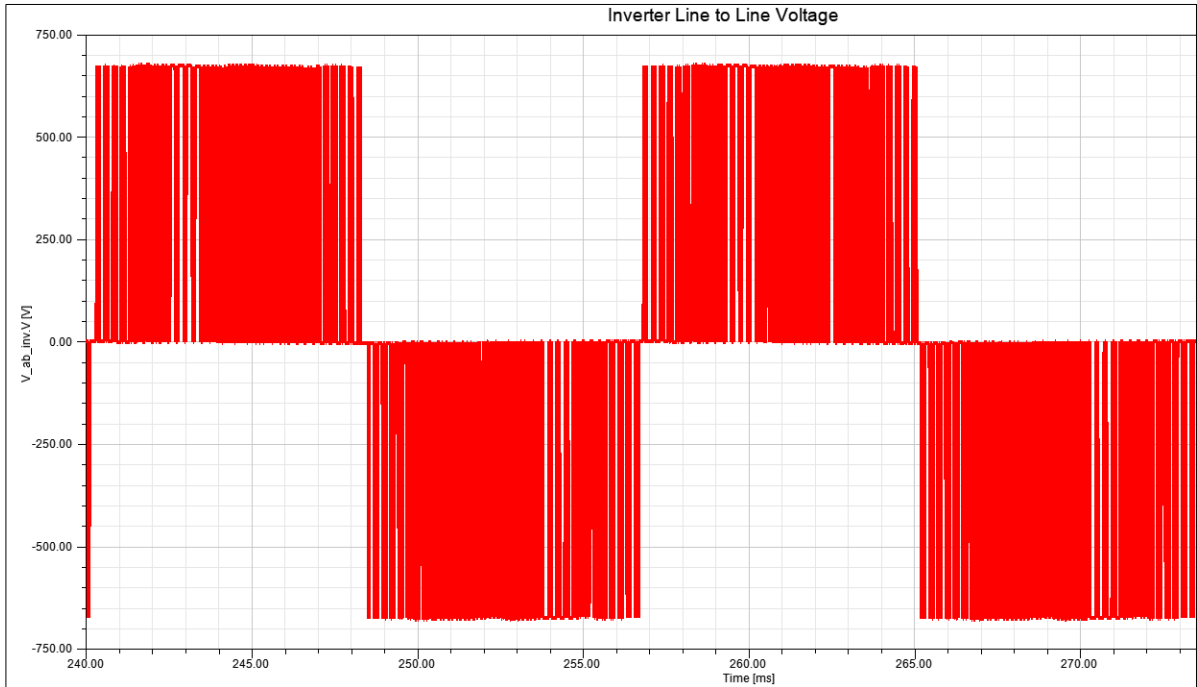

Figure 3-1: Output Voltage before SineWave Nexus

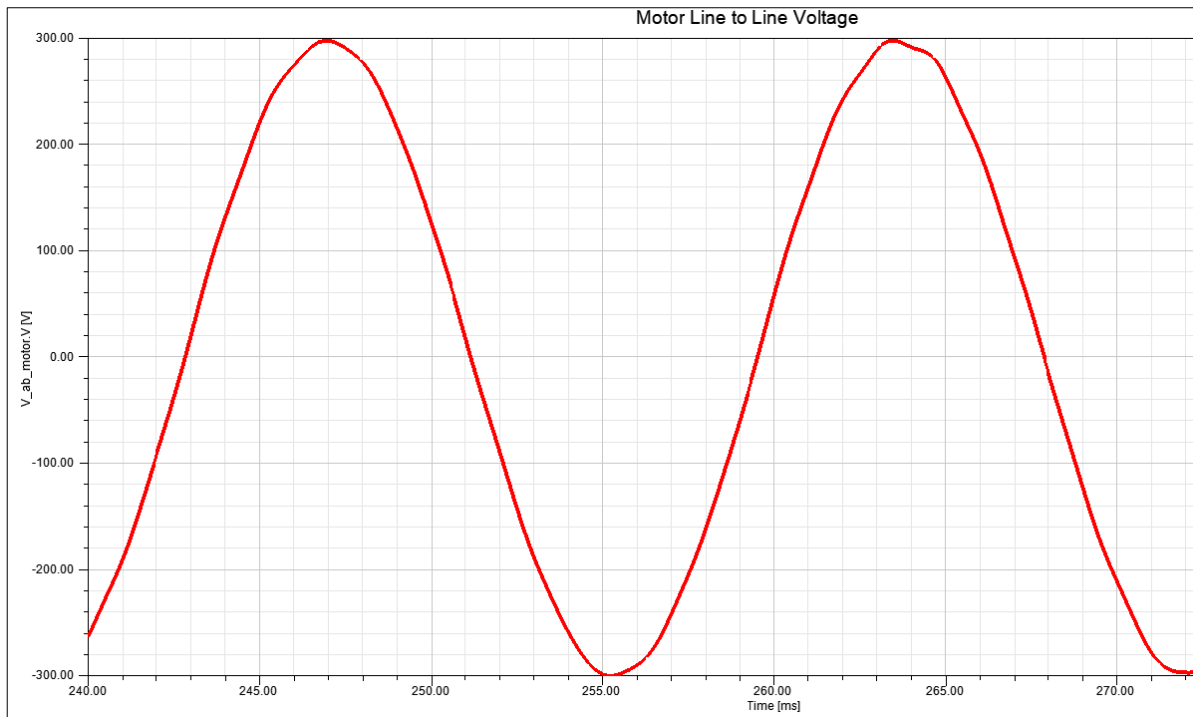

Figure 3-2: Output Voltage after SineWave Nexus

Common Mode Voltage Waveforms

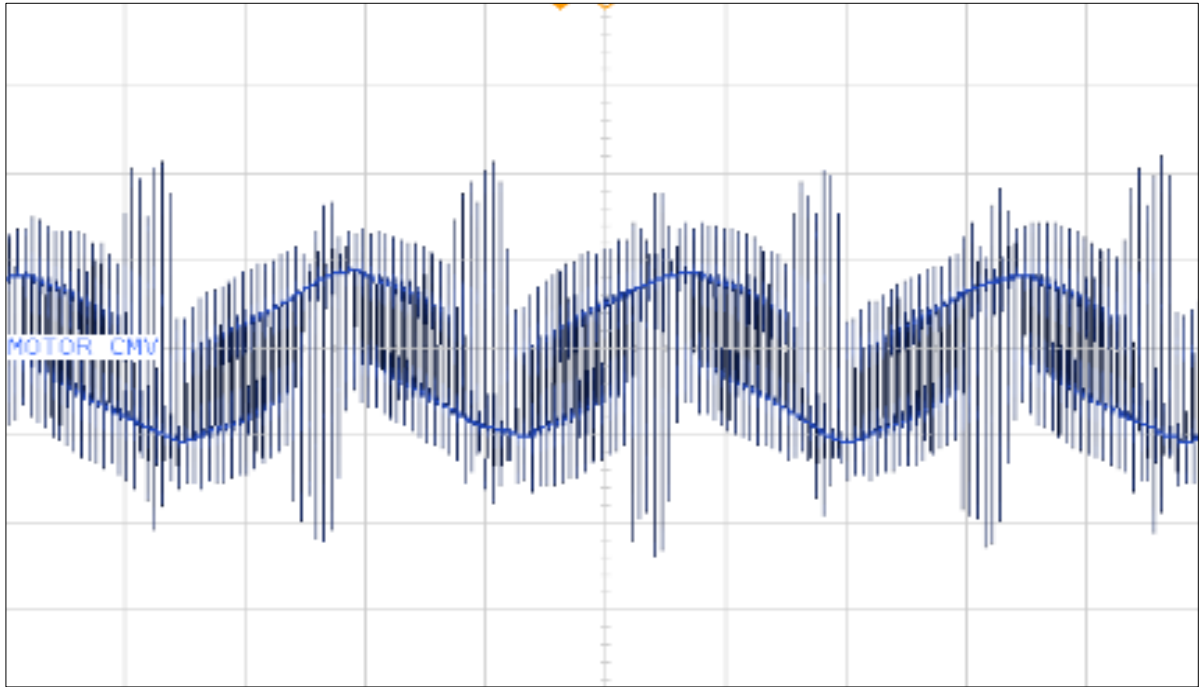

Figure 3-3: Common Mode Voltage without SineWave Nexus

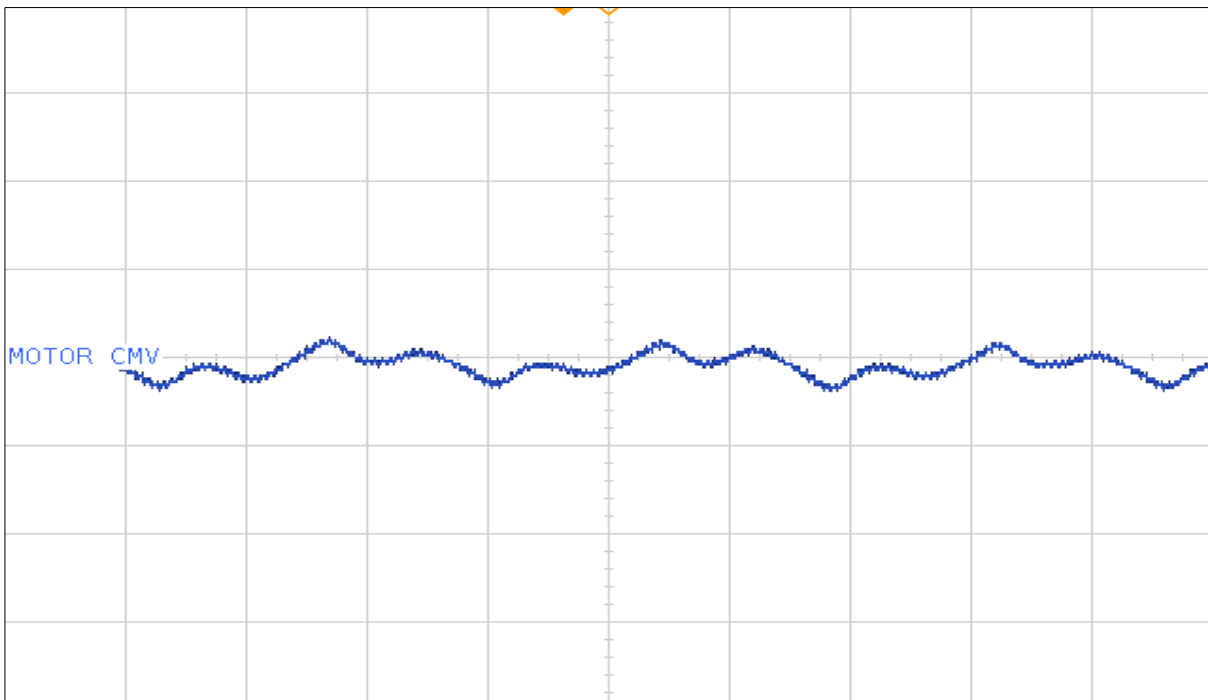

Figure 3-4: Common Mode Voltage with SineWave Nexus

Altitude Derating

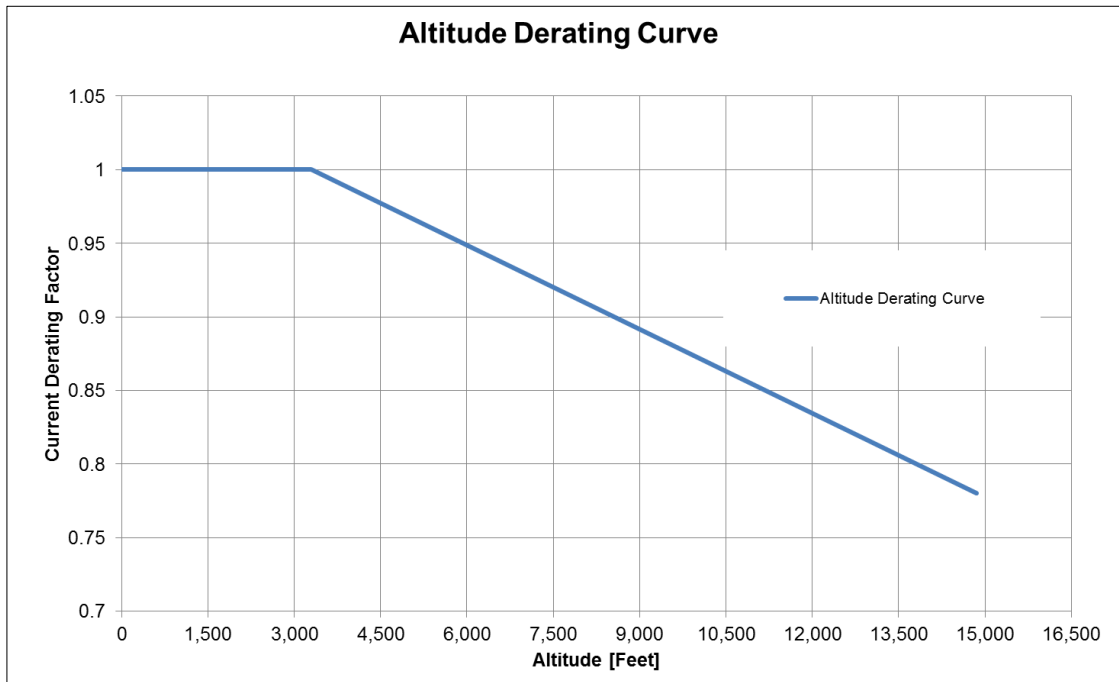

Figure 3-5: Altitude Derating Curve

Motor Frequency Derating

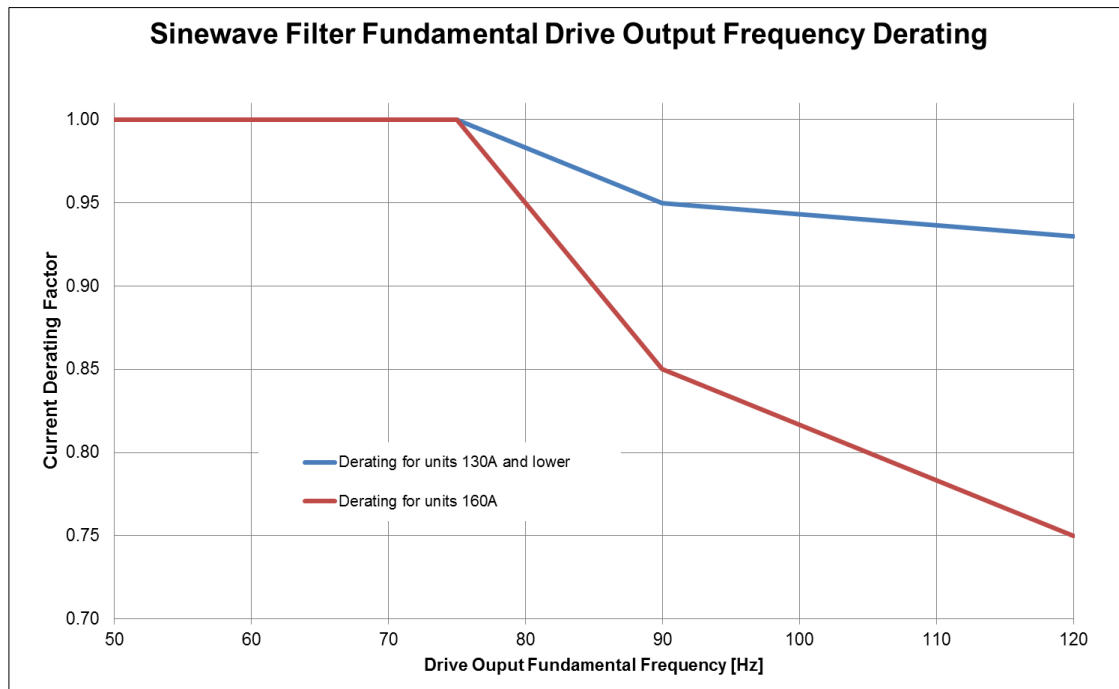

Figure 3-6: Motor Frequency Derating

4. HOW TO SELECT

Selection Guide

MTE's SineWave Nexus motor protection filters are designed to provide a sine wave output voltage when driven from PWM inverters with switching frequencies from 2 kHz to 8 kHz. For drive applications, these filters eliminate the problem of motor insulation failures and they also reduce electromagnetic interference by eliminating the high dV/dt associated with inverter output wave forms.

SineWave Nexus motor protection filters are available in Modular, NEMA 1/2, and NEMA 3R mechanical configurations.

Please verify information below for proper selection:

- Lead Length:** This product is suitable for applications with motor leads up to 15,000 ft. Contact MTE Application Engineering for possible longer applications.
- Voltage:** Input voltage from 380V – 600V. See Table 3-1: Performance Specifications (p5) for specification.
- Current Rating:** Support for 2 Amps – 160 Amps.
- Switching Frequency:** Support for carrier frequency of 2kHz – 8kHz; see Table 3-1: Performance Specifications (p5). (Optimal performance achieved @ 4kHz)
- Drive Output Frequency:** Support for 6Hz to 75Hz without derating, >75Hz to 120Hz with derating. See Figure 3-6: Motor Frequency Derating (p10) for derating curve.
- Temperature:** Maximum ambient temperature, 60C (modular), 55C (enclosed). See Table 3-1: Performance Specifications (p5) for specification.
- Altitude:** 3,300 feet above sea level without derating, see Figure 3-5: Altitude Derating Curve (p10) for derating curve.
- Enclosure Type:** Modular, NEMA 1/2 & NEMA 3R, see Enclosures (p4) for enclosure descriptions.
- Verify the drive output can be configured to Volts per Hz mode.
- Refer to Article 430 Table 430.91 of the National Electrical code for the selection of the appropriate enclosure Type Number for your application.

Understanding the SineWave Nexus Part Number

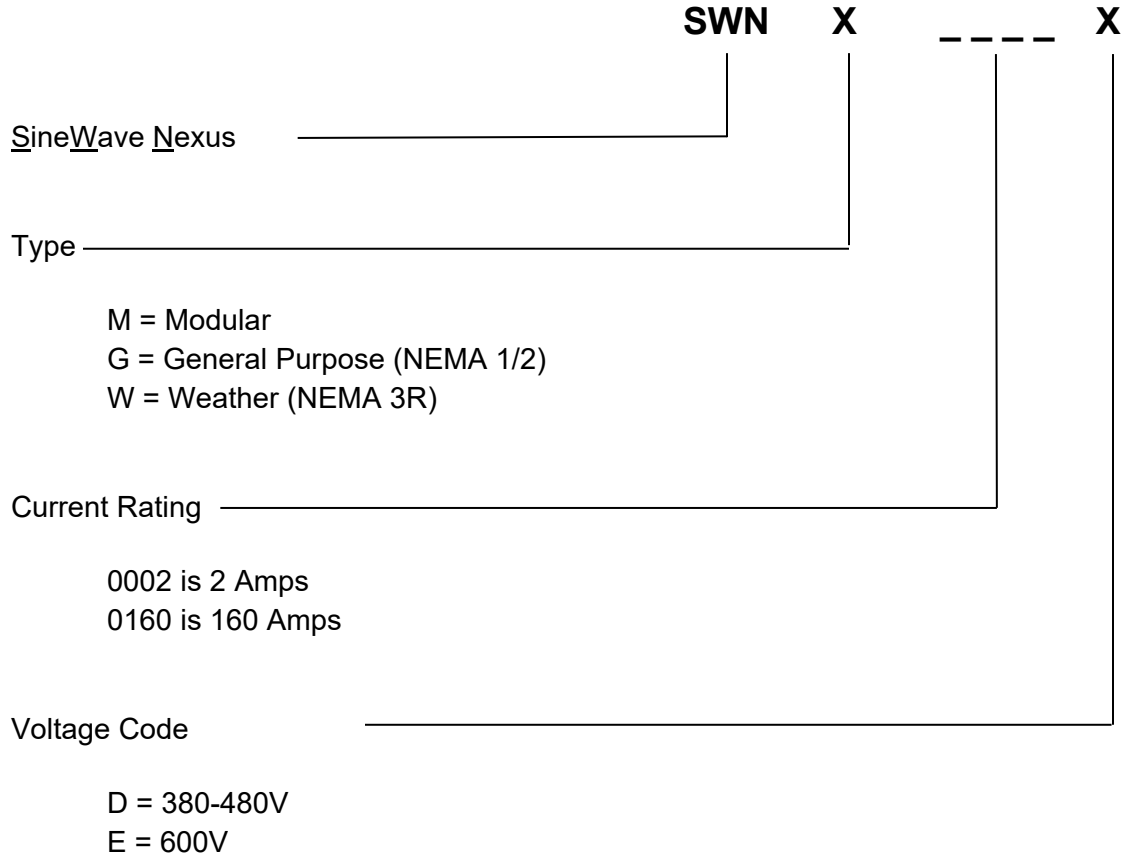

SineWave Nexus 380-480V, 60Hz Selection Tables

Table 4-1: SineWave Nexus 380-480V Open Panel

380V Motor KW	480V Motor HP	Filter Amp Rating	Part Number	App. Wt. (lbs.)	Open Magnetics (in.) (H x W x D)	3-Phase Capacitor (in.) (H x D)	Common Mode Assembly (in.) (H x W x D)
0.55	0.75	2	SWNM0002D	12	8.2 x 6.9 x 4.2	7.5 x 3.0	3.0 x 5.8 x 3.3
0.75	1.5	3	SWNM0003D	14	8.2 x 6.9 x 4.5	7.5 x 3.0	3.0 x 5.8 x 3.3
2.2	3	5	SWNM0005D	19	8.2 x 6.9 x 4.8	7.5 x 3.0	4.3 x 9.4 x 5.1
5.5	7.5	12	SWNM0012D	32	10.2 x 8.8 x 5.8	7.5 x 3.0	4.3 x 9.4 x 5.1
7.5	10	17	SWNM0017D	51	13.1 x 11.0 x 6.6	7.5 x 3.0	4.3 x 9.4 x 5.1
11	15	22	SWNM0022D	61	13.1 x 11.0 x 7.1	7.5 x 3.0	4.3 x 9.4 x 5.1
15	20	27	SWNM0027D	62	13.1 x 11.0 x 7.1	7.5 x 3.0	4.3 x 9.4 x 5.1
22	30	45	SWNM0045D	67	13.2 x 11.0 x 7.6	7.5 x 3.9	4.3 x 9.4 x 5.1
37	50	65	SWNM0065D	94	15.6 x 15.0 x 9.0	8.3 x 4.6	4.3 x 9.4 x 5.1
55	75	110	SWNM0110D	141	15.6 x 15.0 x 10.7	8.3 x 4.6	4.3 x 9.4 x 5.1
75	100	130	SWNM0130D	176	15.7 x 15.0 x 12.2	(2) 8.3 x 3.9	4.3 x 9.4 x 5.1
90	125	160	SWNM0160D	210	15.9 x 15.0 x 15.9	8.3 x 3.9 8.3 x 4.6	4.3 x 9.4 x 5.1

SineWave Nexus 380-480V, 60Hz Selection Tables

Table 4-2: SineWave Nexus 380-480V Enclosed NEMA 1/2

380V Motor KW	480V Motor HP	Filter Amp Rating	Part Number	App. Wt. (lbs.)	NEMA 1/2 Enclosure (in.) (H x W x D)
0.55	0.75	2	SWNG0002D	29	13.2 x 13.0 x 13.1
0.75	1.5	3	SWNG0003D	31	13.2 x 13.0 x 13.1
2.2	3	5	SWNG0005D	71	24.0 x 12.5 x 17.9
5.5	7.5	12	SWNG0012D	83	24.0 x 12.5 x 17.9
7.5	10	17	SWNG0017D	102	24.0 x 12.5 x 17.9
11	15	22	SWNG0022D	112	24.0 x 12.5 x 17.9
15	20	27	SWNG0027D	113	24.0 x 12.5 x 17.9
22	30	45	SWNG0045D	118	24.0 x 12.5 x 17.9
37	50	65	SWNG0065D	174	33.9 x 18.3 x 20.9
55	75	110	SWNG0110D	221	33.9 x 18.3 x 20.9
75	100	130	SWNG0130D	255	33.9 x 18.3 x 20.9
90	125	160	SWNG0160D	385	51.3 x 27.7 x 24.9

Table 4-3: SineWave Nexus 380-480V Enclosed NEMA 3R

380V Motor KW	480V Motor HP	Filter Amp Rating	Part Number	App. Wt. (lbs.)	NEMA 3R Enclosure (in.) (H x W x D)
0.55	0.75	2	SWNW0002D	71	24.0 x 12.5 x 23.0
0.75	1.5	3	SWNW0003D	73	24.0 x 12.5 x 23.0
2.2	3	5	SWNW0005D	78	24.0 x 12.5 x 23.0
5.5	7.5	12	SWNW0012D	91	24.0 x 12.5 x 23.0
7.5	10	17	SWNW0017D	110	24.0 x 12.5 x 23.0
11	15	22	SWNW0022D	120	24.0 x 12.5 x 23.0
15	20	27	SWNW0027D	121	24.0 x 12.5 x 23.0
22	30	45	SWNW0045D	126	24.0 x 12.5 x 23.0
37	50	65	SWNW0065D	185	33.9 x 18.3 x 26.0
55	75	110	SWNW0110D	232	33.9 x 18.3 x 26.0
75	100	130	SWNW0130D	266	33.9 x 18.3 x 26.0
90	125	160	SWNW0160D	398	51.3 x 27.7 x 30.0

SineWave Nexus 600V, 60Hz Selection Tables

Table 4-4: SineWave Nexus 600V Open Panel

600V Motor KW	600V Motor HP	Filter Amp Rating	Part Number	App. Wt. (lbs.)	Open Magnetics (in.) (H x W x D)	3-Phase Capacitor (in.) (H x D)	Common Mode Assembly (in.) (H x W x D)
2.2	3	5	SWNM0005E	28	10.2 x 8.8 x 5.3	8.3 x 3.0	4.3 x 9.4 x 5.1
7.5	10	12	SWNM0012E	34	10.2 x 8.8 x 5.8	8.3 x 3.0	4.3 x 9.4 x 5.1
11	15	17	SWNM0017E	65	13.2 x 11.0 x 7.1	8.3 x 3.0	4.3 x 9.4 x 5.1
15	20	22	SWNM0022E	66	13.2 x 11.0 x 7.1	8.3 x 3.0	4.3 x 9.4 x 5.1
18.5	25	27	SWNM0027E	76	13.2 x 11.0 x 7.6	8.3 x 3.0	4.3 x 9.4 x 5.1
30	40	45	SWNM0045E	99	15.7 x 15.0 x 9.1	8.3 x 3.0	4.3 x 9.4 x 5.1
45	60	65	SWNM0065E	114	15.7 x 15.0 x 9.7	8.3 x 4.0	4.3 x 9.4 x 5.1
75	100	110	SWNM0110E	178	15.7 x 15.0 x 12.3	8.3 x 4.6	4.3 x 9.4 x 5.1
90	125	130	SWNM0130E	177	15.8 x 15.0 x 12.1	8.3 x 4.6	4.3 x 9.4 x 5.1

SineWave Nexus 600V, 60Hz Selection Tables

Table 4-5: SineWave Nexus 600V Enclosed NEMA 1/2



600V Motor KW	600V Motor HP	Filter Amp Rating	Part Number	App. Wt. (lbs.)	NEMA 1/2 Enclosure (in.) (H x W x D)
2.2	3	5	SWNG0005E	80	24.0 x 12.5 x 17.9
7.5	10	12	SWNG0012E	85	24.0 x 12.5 x 17.9
11	15	17	SWNG0017E	116	24.0 x 12.5 x 17.9
15	20	22	SWNG0022E	117	24.0 x 12.5 x 17.9
18.5	25	27	SWNG0027E	127	24.0 x 12.5 x 17.9
30	40	45	SWNG0045E	178	33.9 x 18.3 x 20.9
45	60	65	SWNG0065E	194	33.9 x 18.3 x 20.9
75	100	110	SWNG0110E	353	51.3 x 27.7 x 24.9
90	125	130	SWNG0130E	351	51.3 x 27.7 x 24.9

Table 4-6: SineWave Nexus 600V Enclosed NEMA 3R

600V Motor KW	600V Motor HP	Filter Amp Rating	Part Number	App. Wt. (lbs.)	NEMA 3R Enclosure (in.) (H x W x D)
2.2	3	5	SWNW0005E	87	24.0 x 12.5 x 23.0
7.5	10	12	SWNW0012E	93	24.0 x 12.5 x 23.0
11	15	17	SWNW0017E	124	24.0 x 12.5 x 23.0
15	20	22	SWNW0022E	125	24.0 x 12.5 x 23.0
18.5	25	27	SWNW0027E	135	24.0 x 12.5 x 23.0
30	40	45	SWNW0045E	189	33.9 x 18.3 x 26.0
45	60	65	SWNW0065E	205	33.9 x 18.3 x 26.0
75	100	110	SWNW0110E	366	51.3 x 27.7 x 30.0
90	125	130	SWNW0130E	364	51.3 x 27.7 x 30.0

5. HOW TO INSTALL

Installation Checklist

 WARNING	<p>Prior to installation, please review the safety instructions on page 1 & 2. Failure to practice this can result in body injury!</p>
	<p>Input and output wiring to the filter should be performed by authorized personnel in accordance with NEC and all local electrical codes and regulations.</p>
 WARNING	<p>The filter is designed for use with copper conductors with a minimum temperature rating of 75 degrees C.</p>

SineWave Nexus filters are supplied in the following mechanical configurations:

- Modular: Modular units consist of a reactor, a common mode assembly and one or more capacitor or capacitor panel assemblies (referred to as cap-panels on drawings and diagrams). Additional wiring between the reactor, common mode assembly and capacitor/capacitor panel assembly is required by customer.
- Floor mounted general purpose NEMA 1/2 and NEMA 3R cabinets: Reactor, common mode assembly and capacitor/capacitor panel assemblies are supplied in a cabinet with all items pre-wired together.

Minimum Required Space:

Open panel SineWave Nexus filters are designed for mounting within the customer's enclosure. When determining the internal temperature rise and cooling requirements of the enclosure, include the power dissipation of the filter along with all the other components located in the panel. A general guideline is to allow a side clearance of four (4) inches and a vertical clearance of six (6) inches for proper heat dissipation and access within the enclosure. Clearances may be less if proper ventilation exists. Filter components must operate within temperatures specified in this manual or filter operating life will be compromised. Also, be aware of minimum electrical clearances as defined by the appropriate system safety standard(s). Modular SineWave Nexus filters generate heat and should be positioned away from heat sensitive components. Avoid locations where the filter would be subjected to excessive vibrations. Locate the filter as close to the inverter as possible.

NOTE: Locate the capacitor(s) and common mode assembly in the lowest temperature regions of the enclosure – generally toward the bottom and away from high temperature components.

General purpose NEMA 1/2 and NEMA 3R enclosed filters are designed for floor mounting in an environment suitable for the enclosure type. Do not install in or near a corrosive environment. Avoid locations where the filter would be subjected to excessive vibrations. Allow a minimum side and back clearance of eight (8) inches and front clearance of thirty-six (36) inches for proper heat dissipation and access.

Grounding

 WARNING	The filter must always be grounded with a grounding conductor connected to ground terminals.
WARNING	For modular units, ensure a 2" X 2" area is cleaned of paint and varnish on lower mounting bracket for ground connection.

NOTE: For cable shield grounding follow the drive manufacturer’s recommendations.

Grounding and Ground Fault Protection

Due to high leakage currents associated with variable frequency drives, ground fault protective devices do not necessarily operate correctly. When using this type of device, its function should be tested in the actual installation.

Overtemperature Interlock

An overtemperature interlock circuit should be used in conjunction with thermal switch to turn off the drive to prevent filter damage due to abnormal operating conditions. The temperature switch is normally closed and will open when an internal reactor temperature of 180°C is reached. See Table 5-1: Overtemperature Switch, below for contact rating information and the drive user manual for interconnection information.

Table 5-1: Overtemperature Switch

<i>NC Switch</i> opens at 180 Deg. +/- 5 Deg. C		
Current Amps	Voltage	Contact Load
6	120 AC	Resistive Loads
3	120 AC	Inductive Loads
3	240 AC	Resistive Loads
2.5	240 AC	Inductive Loads
8	12 VDC	Resistive Loads
4	24 VDC	Resistive Loads

MTE highly recommends the use of the overtemperature switch to prevent damage to the filter in rare instances of overheating from abnormal operating conditions.

Power Wiring Connection

 WARNING	<p>Input and output power wiring to the filter should be performed by authorized personnel in accordance with the NEC and all local electrical codes and regulations.</p> <p>Cable lugs and mounting hardware are provided by the customer.</p>
	<p>Any extremely low or high resistance readings indicate miswiring and may result in damage to filter components if not corrected.</p>
	<p>On NEMA 3R enclosures, CAB-26AP and larger, no live parts shall be mounted below 8 inches from the bottom of the enclosure.</p>

Verify that the power source to which the filter is to be connected is in agreement with the nameplate data on the filter. A fused disconnect switch or circuit breaker should be installed between the drive and its source of power in accordance with the requirements of the NEC and all local electrical codes and regulations. Refer to the drive user manual for selection of the correct fuse rating and class.

The typical interconnection diagrams that follow are shown for a motor load, but the load can be either a motor or a transformer.

- For modular filter applications, interconnection between the filter, its power source, the capacitor(s), the common mode assembly and the drive is shown in Figure 5-1: Modular Interconnection (p22).
- For filters supplied in general purpose NEMA 1/2 & NEMA 3R cabinets, interconnection between the filter, its power source, the motor, and the drive is shown in Figure 5-2: Enclosed Interconnection (p23).
- For transformers, interconnection between the power source, the filter, the motor and the drive is shown in Figure 5-4: Transformer Diagram (p25).

Wire gauge range and terminal torque requirements as well as selecting conductors that interconnect the reactor, capacitor(s) and common mode assembly are shown in Table 5-2: Torque Ratings 380-480V (p27) and Table 5-3: Torque Ratings 600V (p28).

Refer to the drive user manual for instructions on interconnecting the drive and motor and the correct start-up procedures for the drive.

The filter is designed for use with copper conductors with a minimum temperature rating of 75 degrees C.

Common Mode Assembly Connection

 WARNING	Review the schematic prior to connecting unit in DC Bus Configuration. Connecting the unit incorrectly could result in failure of drive and filter components
	When attempting to connect the filter to the DC Bus of the drive, please consult drive manual/manufacturer for proper connection points. Failure to do so may result in failure of drive or filter components.

The type of power distribution transformer that is used in the system feeding the drive will determine the recommended method for connecting the common mode assembly. The common mode assembly can be connected in two different ways dependent upon the type of system it is used in.

NOTE: The recommended connection configuration for optimal performance is the DC Bus Connected Configuration.

Solidly Grounded or High Resistance Grounded WYE Systems

With a solidly grounded wye or high resistance grounded wye transformer secondary, we recommend using the ground connected configuration, shown in Figure 5-6: Ground Connected Configuration (p26). The common mode assembly is connected in this configuration by default.

Floating WYE or Delta System

With a floating wye transformer secondary or with a delta transformer secondary, we recommend using the DC Bus connected configuration, shown in Figure 5-5: DC Bus Connected Configuration (p26).

Note: Exotic delta transformer secondary schemes like corner grounded delta and high-leg delta are also included in this category.

Systems in Which the Transformer or Grounding Details Are Unknown

If this information is not available, we recommend using the DC Bus Connected Configuration, shown in Figure 5-5: DC Bus Connected Configuration (p26).

Converting from Ground Connected Configuration to DC Bus Connected Configuration

Changing the common mode assembly from the grounded config to the DC Bus connected config can be done in two easy steps.

1. Move jumpers J1 and J2 from the ground connection terminal G to bottom side of terminals 3 and 4 respectively
2. Wire the top side of terminals 3 and 4 to the DC Bus in the drive.

Note: Recommended wire size for this connection is 12-14 AWG

Wiring Checks

Using Figure 5-3: Basic Schematic Diagram (p24), visually check the wired components to confirm, verify, and correct wiring. Then, with a multimeter, check phase to phase isolation using the 100 K ohm range. The multimeter will read the parallel equivalent of the bleeder resistors after the capacitors initially charge. All phase to phase resistance values should be the same.

Check for the Following Faults:

- Capacitor shorted
- Capacitor bus not connected
- Capacitor bus to chassis short
- Parallel wiring errors

Torque Ratings Tables

Please see Table 5-2: Torque Ratings 380-480V (p27) and Table 5-3: Torque Ratings 600V (p28) for torque ratings.

NOTE: Cap-panel interconnect wiring specification according to UL508 75° C Table.

NOTE: To prevent flexing or bending of the coil windings attached to SWN reactor use appropriate strain relief to prevent stress on terminals. For flat copper terminal tabs, use two wrenches to tighten customer provided cable mounting hardware.

NOTE: Refer to reference drawings for termination wire ranges.

Modular Unit Interconnection Diagram

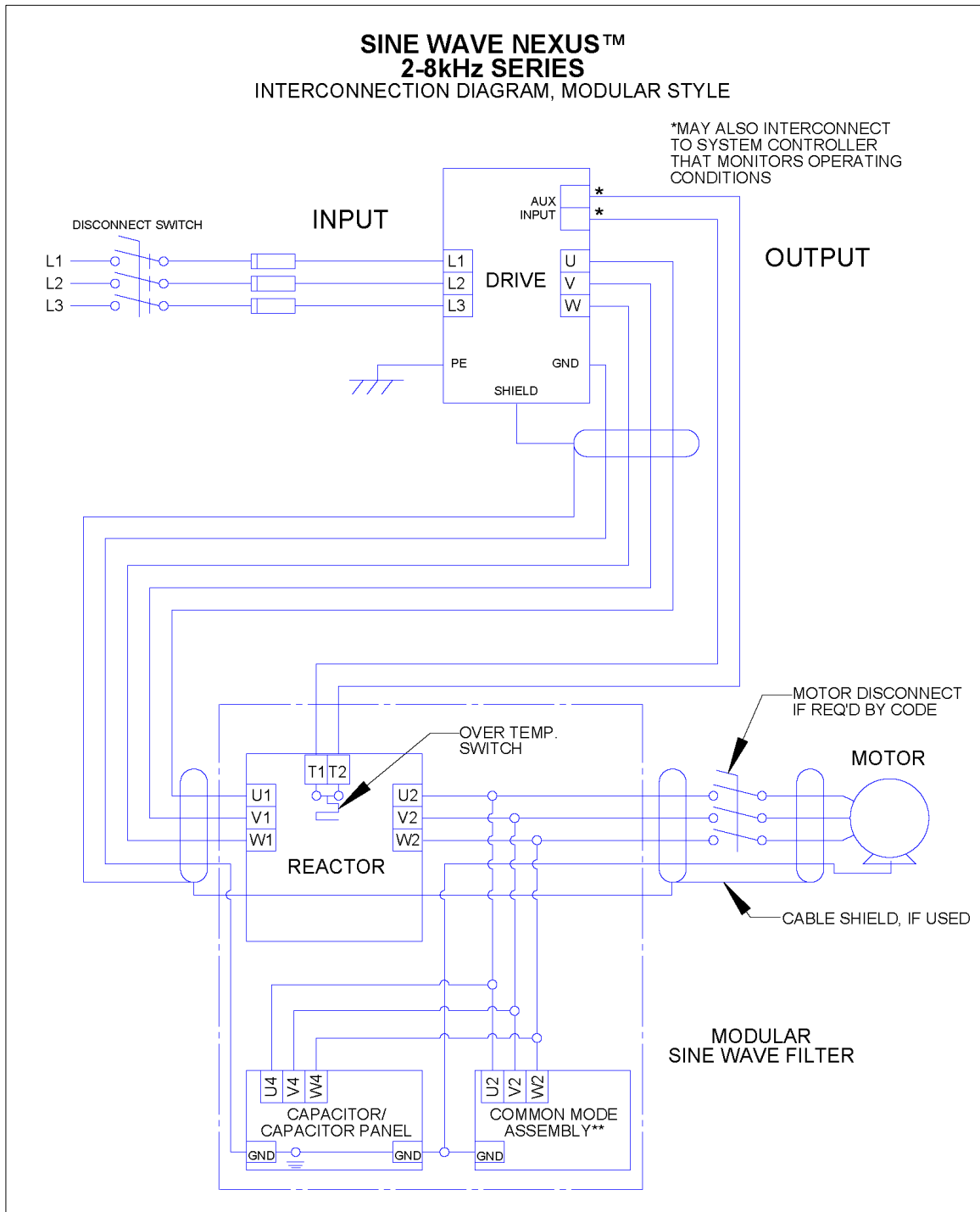

Figure 5-1: Modular Interconnection

**See Figure 5-5 (p26) and Figure 5-6 (p26) for Common Mode Assembly connection diagrams

Enclosed Unit Interconnection Diagram

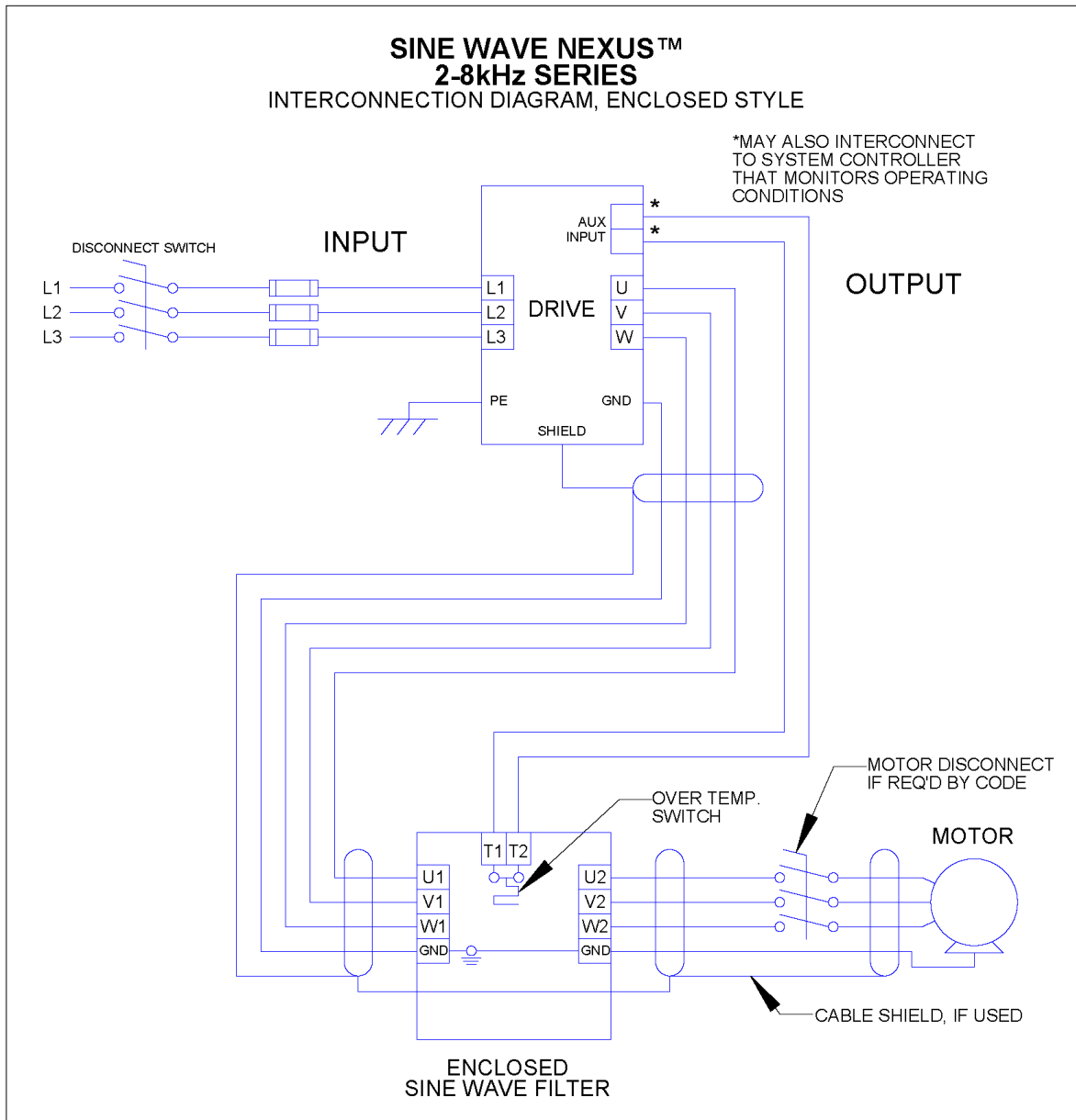

Figure 5-2: Enclosed Interconnection

See Figure 5-5 (p26) and Figure 5-6 (p26) for Common Mode Assembly connection diagrams

Basic Schematic Diagram

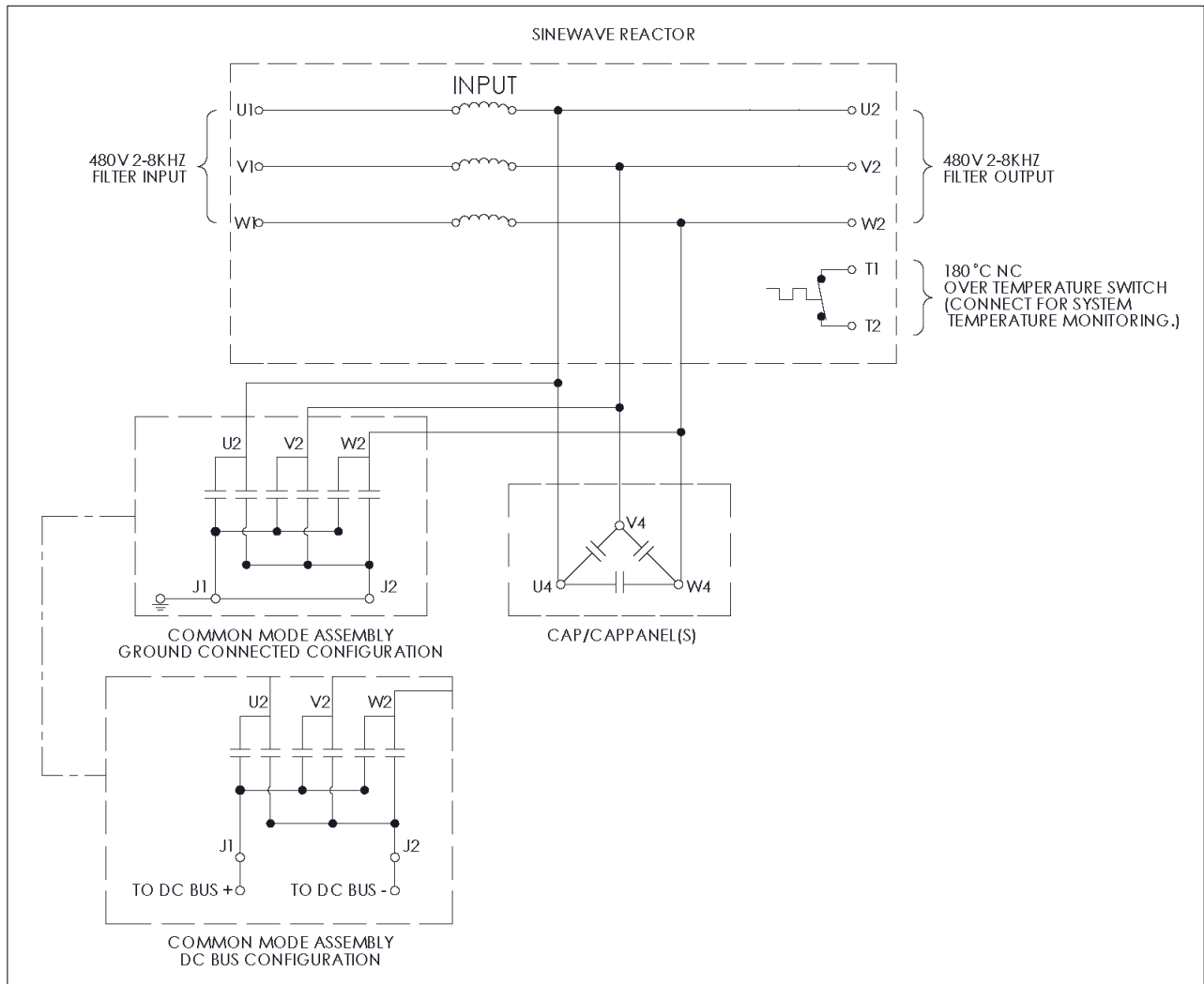

Figure 5-3: Basic Schematic Diagram

See Figure 5-5 (p26) and Figure 5-6 (p26) for Common Mode Assembly connection diagrams

Transformer Diagram

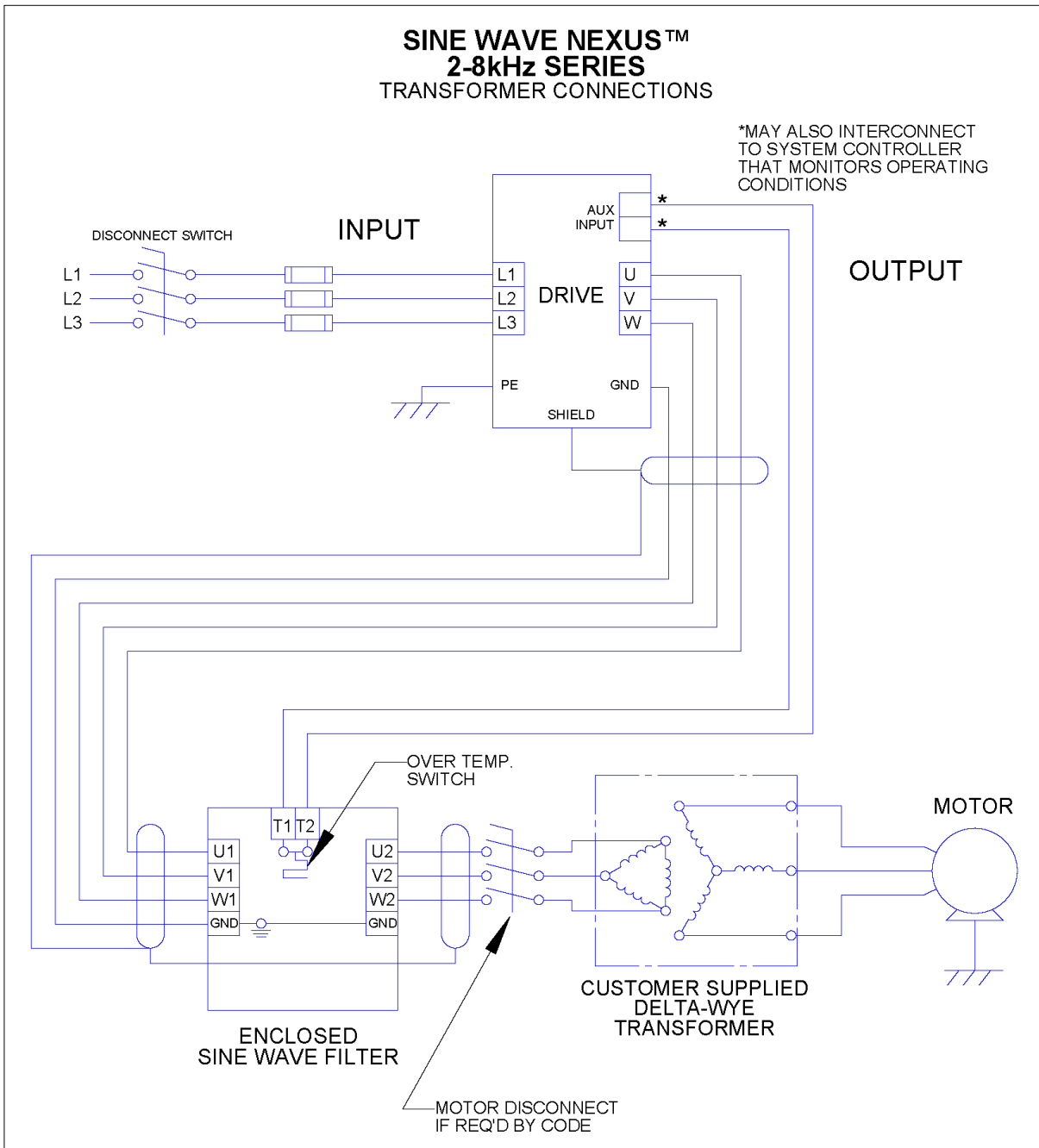

Figure 5-4: Transformer Diagram

See Figure 5-5 (p26) and Figure 5-6 (p26) for Common Mode Assembly connection diagrams

Common Mode Assembly Connection Diagrams

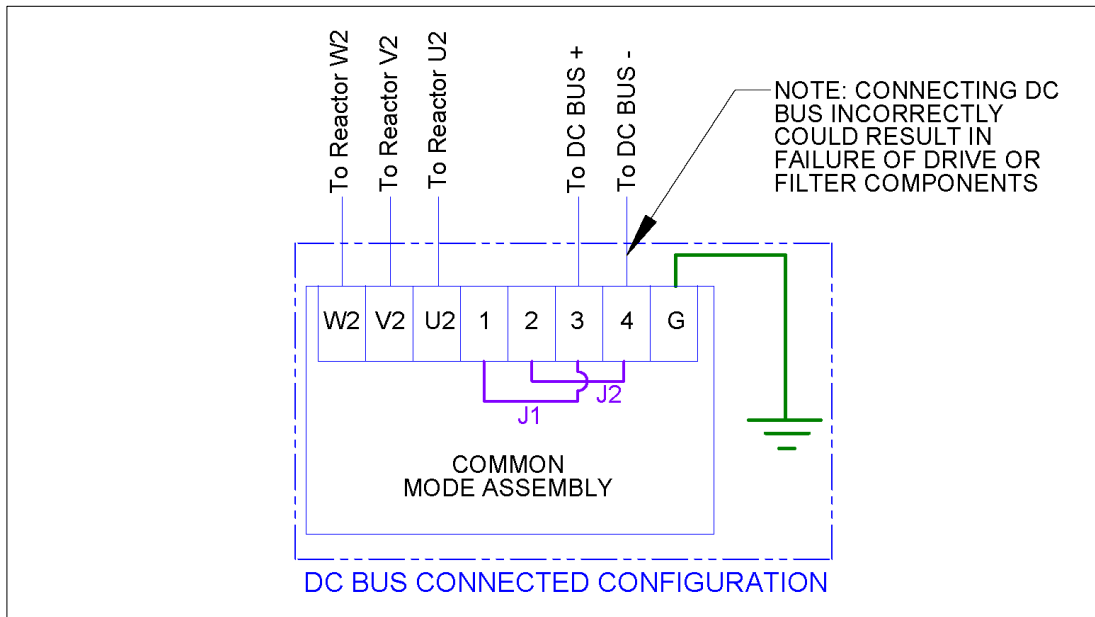

Figure 5-5: DC Bus Connected Configuration

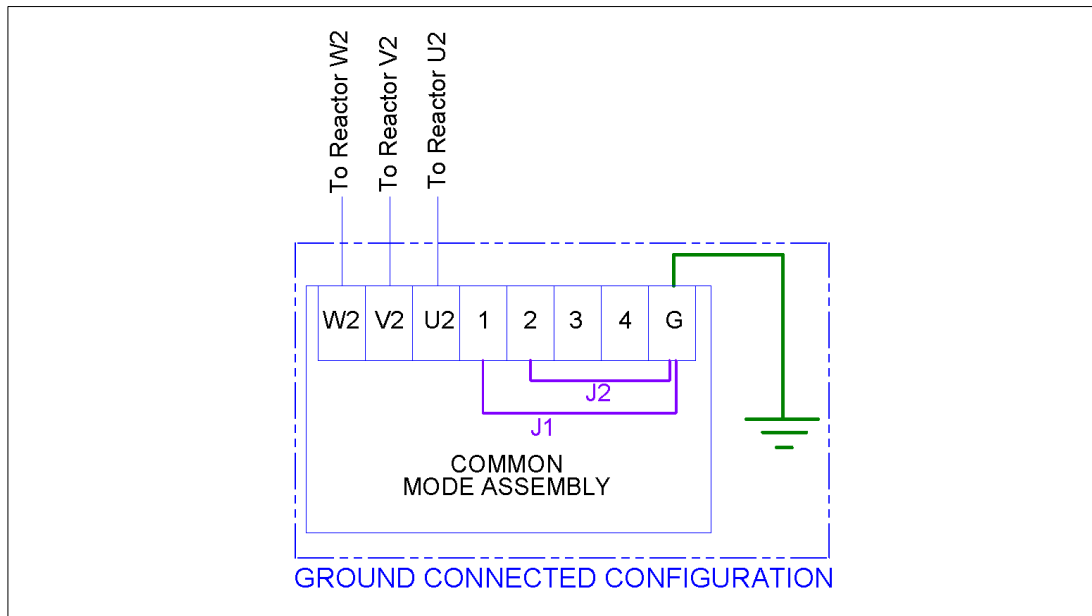

Figure 5-6: Ground Connected Configuration

Note: Refer to the Common Mode Assembly Connection section (p20) for details on converting from the Ground Connected Configuration to the DC Bus Configuration

Torque Ratings 380-480V

Table 5-2: Torque Ratings 380-480V

Filter Rating (Amps)	SWN Terminals			Capacitor/Cap-panel Terminals U4-V4-W4		
	Input /Output Power U1-V1-W1 / U2-V2-W2		U4-V4-W4 interconnect Cap-panel	Capacitor/ Cap-panel Part Number	Minimum Interconnect Wire Gauge (AWG)	Terminal Torque (in-lbs.)
	Recommended Minimum Wire Size (AWG)	Terminal Torque (in-lbs.)	Terminal Torque (in-lbs.)			
2	14	16	N/A	CAP-502SW	14	N/A
3	14	16	N/A	CAP-503SW	14	N/A
5	14	16	N/A	CAP-504SW	14	N/A
12	14	16	N/A	CAP-507SW	14	N/A
17	12	16	N/A	CAP-507SW	14	N/A
22	10	16	N/A	CAP-508SW	14	N/A
27	10	16	N/A	CAP-509SW	14	N/A
45	8	N/A	N/A	CAP-511SW	14	N/A
65	6	N/A	N/A	CAP-514SW	12	N/A
110	2	N/A	N/A	CAP-516SW	12	N/A
130	1	N/A	N/A	(2) CAP-513SW	14/14	N/A
160	4 (2x) or 2/0	N/A	N/A	CAP-512SW CAP-516SW	10/10	N/A

Filter Rating (Amps)	Common Mode Assembly Terminals U4-V4-W4		
	Common Mode Assembly Part Number	Minimum Interconnect Wire Gauge (AWG)	Terminal Torque (in-lbs.)
2	CMB-010	10	16
3	CMB-011	10	16
5	CMB-002	10	16
12	CMB-003	10	16
17	CMB-004	10	16
22	CMB-005	10	16
27	CMB-005	10	16
45	CMB-006	10	16
65	CMB-007	10	16
110	CMB-008	10	16
130	CMB-008	10	16
160	CMB-009	10	16

Torque Ratings 600V

Table 5-3: Torque Ratings 600V



Filter Rating (Amps)	SWN Terminals			Capacitor/Cap-panel Terminals U4-V4-W4		
	Input /Output Power U1-V1-W1 / U2-V2-W2		U4-V4-W4 interconnect Cap-panel	Capacitor/ Cap-panel Part Number	Minimum Interconnect Wire Gauge (AWG)	Terminal Torque (in-lbs.)
	Recommended Minimum Wire Size (AWG)	Terminal Torque (in-lbs.)	Terminal Torque (in-lbs.)			
5	14	16	N/A	CAP-518SW	14	N/A
12	14	16	N/A	CAP-522SW	14	N/A
17	12	16	N/A	CAP-523SW	14	N/A
22	10	16	N/A	CAP-524SW	14	N/A
27	10	16	N/A	CAP-525SW	14	N/A
45	8	N/A	N/A	CAP-527SW	14	N/A
65	6	N/A	N/A	CAP-529SW	14	N/A
110	2	N/A	N/A	CAP-531SW	10	N/A
130	1	N/A	N/A	CAP-532SW	8	N/A

Filter Rating (Amps)	Common Mode Assembly Terminals U4-V4-W4		
	Common Mode Assembly Part Number	Minimum Interconnect Wire Gauge (AWG)	Terminal Torque (in-lbs.)
5	CMB-001	10	16
12	CMB-002	10	16
17	CMB-003	10	16
22	CMB-003	10	16
27	CMB-004	10	16
45	CMB-005	10	16
65	CMB-005	10	16
110	CMB-006	10	16
130	CMB-006	10	16

6. START-UP

Safety Precautions



Before start-up, observe the following warnings and instructions:

 WARNING	<p>Internal components of the filter are at line potential when the filter is connected to the drive. This voltage is extremely dangerous and may cause death or severe injury if you come in contact with it.</p>
	<p>Remove all power to the SineWave filter in compliance to standardized 26 CFR 1920.147 lockout/tagout policies. After disconnecting the utility power, allow at least 5 minutes to elapse and verify that the capacitors have discharged to a safe level before contacting internal components. Connect a DC voltmeter across the capacitor terminals and ensure that the voltage is at a safe level.</p>
	<p>Use extreme caution to avoid contact with line voltage when checking for power. INJURY OR DEATH MAY RESULT IF SAFETY PRECAUTIONS ARE NOT OBSERVED.</p>
	<p>Review the schematic prior to connecting unit in DC Bus Configuration. Connecting the unit incorrectly could result in failure of drive and filter components.</p>
 Caution	<p>Prior to start-up; confirm the drive operation mode is properly set (Volts per Hertz). Please consult drive manual/manufacturer to configure proper parameters. Failure to do so may result in failure of drive or filter components.</p>
	<p>Damage to the filter may occur if the switching frequency is not set between 2 kHz and 8 kHz. Optimum switching frequency is at 4kHz and above.</p>
	<p>MTE recommends 10 seconds as an initial starting point for motor ramp time and that customers examine the actual inrush and ratings of their drive system. Inrush current seen at the drive from the filter that can easily be overcome by changing the motor ramp time.</p>

Sequence of Operation

1. Read and follow safety precautions.
2. After installation, ensure that:
 - a. All filter ground terminals are connected to ground.
 - b. Power wiring to the utility, drive, filter and motor is in accordance with the power wiring connection diagrams shown in installation instructions section.
3. Check that moisture has not condensed on the filter components. If moisture is present, do not proceed with start-up until the moisture has been removed.
4. Disconnect filter output terminals from the motor.
5. Set the drive switching frequency between 2 kHz and 8 kHz. Refer to the drive user manual.
6. Connect filter temperature safety overload switch into the control circuit so that the drive will shut down in an overload situation.
7. Confirm that drive voltage is present at the input terminals (U1, V1, W1) of the filter.
8. Confirm that drive voltage is present at the output terminals (U2, V2, W2) of the filter.
9. Connect the filter output to the motor.
10. Refer to the drive user manual for the drive start-up procedure. Observe all safety instructions in the drive user manual.

7. TROUBLESHOOTING

 WARNING	<p>When properly installed, this equipment has been designed to provide maximum safety for operating personnel. However, hazardous voltages and elevated temperatures exist within the confines of the enclosure. Servicing should therefore be performed by qualified personnel only and in accordance with OSHA Regulations.</p>
	<p>High voltage is used in the operation of this filter. Use Extreme caution to avoid contact with high voltage when operating, installing or repairing this filter. INJURY OR DEATH MAY RESULT IF SAFETY PRECAUTIONS ARE NOT OBSERVED.</p>
 Caution	<p>After removing power, allow at least five minutes to elapse and verify that the capacitors have discharged to a safe level before contacting internal components. Connect a DC voltmeter across the capacitor terminals or terminals U1, V1 or V1, W1 and ensure that the voltage is at a safe level.</p>

To aid in troubleshooting, a basic schematic diagram, interconnection diagrams, common mode assembly connection diagrams and a troubleshooting guide that lists potential problems and solutions are included:

Figure 5-1: Modular Interconnection (p22)

Figure 5-2: Enclosed Interconnection (p23)

Figure 5-3: Basic Schematic Diagram (p24)

Figure 5-4: Transformer Diagram (p25)

Figure 5-5: DC Bus Connected Configuration (p26)

Figure 5-6: Ground Connected Configuration (p26)

Table 7-1: Troubleshooting Guide (p32)

Table 7-1: Troubleshooting Guide

PROBLEM: Drive Overcurrent Fault	
Possible cause:	Motor ramp-up time too short.
Solution:	MTE suggests a ramp time of >5-10 seconds. Consult drive manufacturers manual to configure proper parameters.
Possible cause:	Failed or incorrect wiring
Solution:	Verify all field and product wiring is correct.
Possible cause:	Parameter compatibility.
Solution:	Consult drive manufacturer's manual for operating drive with a motor protection filter.
Possible cause:	Filter, Drive, Motor current ratings incompatible.
Solution:	Verify the filter and motor are properly sized for the application.
Possible cause:	Drive not configured for Volts/ Hertz.
Solution:	Consult drive manufacturers manual to configure proper parameters.
Possible cause:	Motor winding fault.
Solution:	Verify motor windings and hi-pot is necessary.
Possible cause:	Cable failure.
Solution:	Verify cable continuity and insulation.
PROBLEM: Excessive Filter Noise	
Possible cause:	Mismatched motor rating.
Solution:	Verify the filter is properly sized for the application.
Possible cause:	Capacitors disconnected or improperly wired.
Solution:	Verify the proper connection of the capacitors.
Possible cause:	Carrier frequency less than 2 kHz.
Solution:	Verify the carrier frequency is at least 2 kHz.
PROBLEM: Temperature Switch Open	
Possible cause:	Mismatched motor rating.
Solution:	Verify the filter is properly sized for the application.
Possible cause:	Capacitors disconnected or improperly wired.
Solution:	Verify the proper connection of the capacitors.
Possible cause:	Carrier frequency less than 2 kHz.
Solution:	Verify the carrier frequency is at least 2 kHz.
Possible cause:	Excessive ambient temperature.
Solution:	Ensure filter is operating within specified ambient temperature below 60° C.
PROBLEM: Motor will not turn.	
Possible cause:	No power.
Solution:	Check fuses or breakers for proper input power.
Possible cause:	Motor incorrectly wired.
Solution:	Check for wiring faults.
Possible cause:	Locked rotor motor load.
Solution:	Check motor load.
Possible cause:	Drive fault.
Solution:	Consult drive manufacturers manual.
Possible cause:	Capacitors disconnected or improperly wired.
Solution:	Verify the proper connection of the capacitors.
Possible cause:	Overloaded motor.
Solution:	Verify the motor is properly sized for the application.

PROBLEM:	Common Mode not filtering as expected.
Possible cause:	Grounding on the distribution transformer is insufficient.
Solution:	Change common mode assembly configuration from grounded connected to DC Bus connected.
Possible cause:	Ground connection was not made properly on the unit.
Solution:	Change common mode assembly configuration from grounded connected to DC Bus connected.
Possible cause:	For DC bus connected configuration, unit was not connected to the DC Bus.
Solution:	For proper connection of the DC Bus connected configuration refer to Figure 5-5: DC Bus Connected Configuration (p26).