

SineWave Guardian®

208V – 600V

INSTALLATION GUIDE

FORM: SWG-IG-E
REL. August 2020
REV. 004
© 2020 MTE Corporation

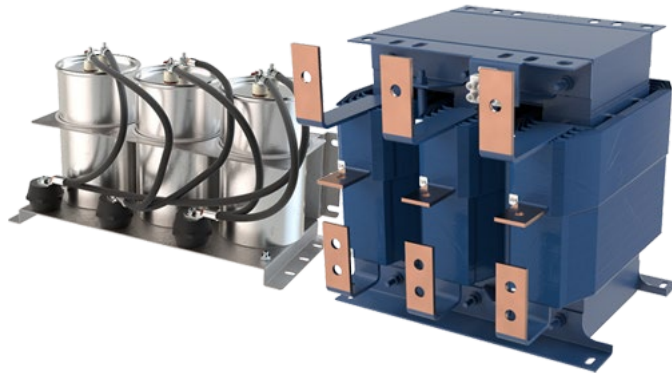

High Voltage! Only a qualified electrician can carry out the electrical installation of this filter.

Quick Reference

1	How to Install	Pages 6 – 19
2	Startup/Troubleshooting	Pages 20 – 24

TABLE OF CONTENTS

1. SAFETY	3
WARNINGS AND CAUTIONS.....	3
GENERAL SAFETY INSTRUCTIONS.....	4
2. INTRODUCTION	5
RECEIPT & REPAIR STATEMENT	5
WARRANTY.....	5
3. HOW TO INSTALL	6
INSTALLATION CHECKLIST	6
GROUNDING	7
POWER WIRING CONNECTION	9
BASIC SCHEMATIC DIAGRAM	11
MODULAR UNIT INTERCONNECTION DIAGRAM	12
ENCLOSED UNIT INTERCONNECTION DIAGRAM.....	13
ISOLATION TRANSFORMER DIAGRAM	14
TORQUE RATINGS 208V-240V	15
TORQUE RATINGS 380V-480V	16
TORQUE RATINGS 600V	18
4. START UP	20
STARTUP CHECKLIST	20
5. TROUBLESHOOTING	22
SINEWAVE GUARDIAN MOTOR PROTECTION FILTER FIELD CHECKS	23

List of Figures

Figure 3-1: Basic Schematic Diagram	11
Figure 3-2: Modular Interconnection	12
Figure 3-3: Enclosed Interconnection	13
Figure 3-4: Isolation Transformer.....	14



List of Tables

Table 3-1: Over Temperature Switch.....	8
Table 3-2: Torque Ratings 208V-240V	15
Table 3-3: Torque Ratings 380-480V	16
Table 3-4: Torque Ratings 600V	18
Table 5-1: Performance Specifications	22
Table 5-2: Troubleshooting Guide	24



1. SAFETY

Warnings and Cautions

The following symbols are used in this manual.

 WARNING	High Voltage Warning: warns of situations that dangerously high voltage is involved. Failure to use proper precautions may lead to serious injury or even death.
 WARNING	General Warning: warns of situations that can result in serious injury or death if proper precautions are not used.
 Caution	General Caution: identifies situations that could lead to malfunction or possible equipment damage.

General Safety Instructions

 WARNING	<p>High Voltage! Only a qualified electrician can carry out the electrical installation of this filter.</p>
	<p>High voltage is used in the operation of this filter. Use extreme caution to avoid contact with high voltage when operating, installing or repairing this filter. Injury or death may result if safety precautions are not observed.</p>
 WARNING	<p>The opening of the branch circuit protective device may be an indication that a fault current has been interrupted. To reduce the risk of fire or electrical shock, current-carrying parts and other components of the filter should be examined and replaced if damaged.</p>
	<p>An upstream disconnect/protection device must be used as required by the National Electrical Code (NEC) or governing authority.</p>
	<p>Even if the upstream disconnect/protection device is open, the drive down stream of the filter may feedback high voltage to the filter. The drive safety instructions must be followed. Injury or death may result if safety precautions are not observed.</p>
	<p>The filter must be grounded with a grounding conductor connected to all grounding terminals. Open panel filters must have reactor grounded through a 2"x2" area cleaned of paint and varnish on lower mounting bracket.</p>
	<p>Only spare parts obtained from MTE Corporation or an authorized MTE distributor can be used.</p>
	<p>After removing power, allow at least five minutes to elapse and verify that the capacitors have discharged to a safe level before contacting internal components. Connect a DC voltmeter across the capacitor terminals and ensure that the voltage is at a safe level.</p>
 Caution	<p>Loose or improperly secured connections may damage or degrade filter performance. Visually inspect and secure all electrical connections before power is applied to the filter.</p>
	<p>Prior to start up; confirm the drive operation mode is properly set. Please consult drive manual/manufacturer to configure proper parameters. Failure to do so may result in failure of drive or filter components.</p>

2. INTRODUCTION

The purpose of the manual is to aid in the proper installation of the SineWave Guardian.

For most current information, please refer to website:

www.mtecorp.com/sinewave-guardian/

SineWave Guardian filters transform the output of Variable Frequency Drives (VFDs) to a near perfect sinusoidal waveform for the best level of motor protection. MTE's unique, patented design offers high performance with smaller size and better efficiency than traditional LC Filters.

Receipt & Repair Statement

Upon Receipt of this Filter:

The SineWave Guardian motor protection filter has been subjected to demanding factory tests before shipment. Carefully inspect the shipping container for damage that may have occurred in transit. Then unpack the filter and carefully inspect for any signs of damage. Save the shipping container for future transport of the filter.

In the event of damage, please contact and file a claim with the freight carrier involved immediately.

If the equipment is not going to be put into service upon receipt, cover and store the filter in a clean, dry location. After storage, ensure that the equipment is dry, and that no condensation or dirt has accumulated on the internal components of the filter before applying power.

Repair/Exchange Procedure

MTE Corporation requires a Return Material Authorization Number and form before we can accept any filters that qualify for return or repair. If problems or questions arise during installation, setup, or operation of the filter, please contact MTE for assistance at:

Toll Free: 1-800-455-4MTE (1-800-455-4683)

International Tel: (+1) 262-253-8200



Fax: 262-253-8222

Warranty

Three years from the date of shipment. See <http://www.mtecorp.com/industry-leading-warranty/> for details.

3. HOW TO INSTALL

Installation Checklist

 WARNING	Prior to installation, please refer to all general warnings on page 4 & 5. Failure to practice this can result in body injury!
	Input and output wiring to the filter should be performed by authorized personnel in accordance with NEC and all local electrical codes and regulations.
 WARNING	The filter is designed for use with copper conductors with a minimum temperature rating of 75 degrees C.

SineWave Guardian filters are supplied in the following mechanical configurations:

- Modular: Modular units consist of a reactor and one or more capacitor panel assemblies referred to as cap-panels on drawings and diagrams. Additional wiring between the reactor and capacitor/capacitor panel is required by customer.
- Floor mounted general purpose NEMA 1/2, & NEMA 3R cabinets: Reactor and capacitor/capacitor assemblies are supplied in a cabinet with all items pre-wired together.

Select a well-ventilated area suitable for the NEMA enclosure type number. Do not install in or near a corrosive environment. Avoid locations where the filter would be subjected to excessive vibrations.

Modular units are designed for mounting within the customer's enclosure.

The capacitor panel must be located in the lowest temperature regions of the enclosure – generally toward the bottom and away from high temperature components.

Include the power dissipation of the filter along with all the other components located in the enclosure to determine the internal temperature rise and cooling requirements of the enclosure.

Refer to Article 430 Table 430.91 of the National Electrical code for the selection of the appropriate enclosure Type Number for your application.

Grounding

 WARNING	<p>The filter must always be grounded with a grounding conductor connected to ground terminals.</p>
	<p>For modular units, ensure a 2" x 2" area is cleaned of paint and varnish on lower mounting bracket for ground connection.</p>
	<p>On NEMA 3R enclosures, CAB-26AP and larger, no live parts shall be mounted below 8 inches from the bottom of the enclosure</p>

NOTE: For cable shield grounding follow the drive manufacturer's recommendations.

Grounding and Ground Fault Protection

Due to high leakage currents associated with variable frequency drives, ground fault protective devices do not necessarily operate correctly when placed ahead of a SineWave Guardian Filter feeding a drive. When using this type of device, its function should be tested in the actual installation.

Location & Spacing

Modular SineWave Guardian filters are designed for mounting within the customer's enclosure. When determining the internal temperature rise and cooling requirements of the enclosure, include the power dissipation of the filter along with all the other components located in the panel. A general guideline is to allow a side clearance of four (4) inches and a vertical clearance of six (6) inches for proper heat dissipation and access within the enclosure. Clearances may be less if proper ventilation exists. Filter components must operate within temperatures specified in this manual or filter operating life will be compromised. Also, be aware of minimum electrical clearances as defined by the appropriate system safety standard(s). Modular SineWave Guardian filters generate heat and should be positioned away from heat sensitive components. Avoid locations where the filter would be subjected to excessive vibrations. Locate the filter as close to the inverter as possible.

General purpose NEMA 1/2, and NEMA 3R enclosed filters are designed for floor mounting in an environment suitable for the enclosure type. Do not install in or near a corrosive environment. Avoid locations where the filter would be subjected to excessive vibrations. Allow a minimum side and back clearance of eight (8) inches and front clearance of thirty-six (36) inches for proper heat dissipation and access. For lower ambient temperatures and increased air flow clearance distances can be reduced.

Over Temperature Interlock

An over temperature interlock circuit should be used in conjunction with thermal switch to turn off the drive to prevent filter damage due to abnormal operating conditions. The temperature switch is normally closed and will open when an internal reactor temperature of 180°C is reached. See Table 3-1 below for contact rating information and the drive user manual for interconnection information.

Table 3-1: Over Temperature Switch

NC Switch opens at 180 Deg. +/- 5 Deg. C		
Current Amps	Voltage	Contact Load
6	120 AC	Resistive Loads
3	120 AC	Inductive Loads
3	240 AC	Resistive Loads
2.5	240 AC	Inductive Loads
8	12 VDC	Resistive Loads
4	24 VDC	Resistive Loads

MTE highly recommends the use of the over temperature switch to prevent damage to the filter in rare instances of overheating from abnormal operating conditions

Power Wiring Connection

 WARNING	Input and output power wiring to the filter should be performed by authorized personnel in accordance with the NEC and all local electrical codes and regulations. Cable lugs and mounting hardware are provided by the customer.
	Any extremely low or high resistance readings indicate miswiring and may result in damage to filter components if not corrected.
	On NEMA 3R enclosures, CAB-26AP and larger, no live parts shall be mounted below 8 inches from the bottom of the enclosure.

Verify that the power source to which the filter is to be connected is in agreement with the nameplate data on the filter. A fused disconnect switch or circuit breaker should be installed between the filter and its source of power in accordance with the requirements of the NEC and all local electrical codes and regulations. Refer to the drive user manual for selection of the correct fuse rating and class.

The typical interconnection diagrams that follow are shown for a motor load, but the load can be either a motor or a transformer.

- For panel mounted filter applications, interconnection between the filter, its power source, the cap-panels, and the drive is shown in Figure 3-2 (p12).
- For filters supplied in general purpose NEMA 1/2 & NEMA 3R cabinets, interconnection between the filter, its power source, and the drive is shown in Figure 3-3 (p13).
- For isolation transformer connections between the filter, motor and the drive is shown in Figure 3-4 (p14).

NOTE: Standard 600V cable can be used between the SineWave Guardian and the motor, however it is recommended that shielded cable be used if the intention is to mitigate common mode. If shielded cable is used between the filter and motor, it must be grounded accordingly. For optimal common mode mitigation, MTE recommends the [SineWave Nexus](#) motor protection filter.

Refer to the drive user manual for instructions on interconnecting the drive and motor and the correct start-up procedures for the drive.

The filter is designed for use with copper conductors with a minimum temperature rating of 75 degrees C.

Wiring Checks

Using Figure 3-1: Basic Schematic Diagram (p11), visually check the wired components to confirm, verify, and correct wiring. Then, with a multi meter check phase to phase isolation using the 100 K ohm range. The multi meter will read the parallel equivalent of the bleeder resistors after the capacitors initially charge. All phase to phase resistance values should be the same.

Check for the Following Faults:

- Capacitor shorted
- Capacitor bus not connected
- Capacitor bus to chassis short
- Paralleling wiring errors

Torque Ratings Tables

Please see Table 3-2: Torque Ratings 208V-240V (p15), Table 3-3: Torque Ratings 380-480V (p16), and Table 3-4: Torque Ratings 600V (p18) for torque ratings.

NOTE: All capacitor and cappanel part numbers will be CAP-xxxTP, CAP-xxxSW, CAPPANEL-xxx or CAPPANEL-xxxC.

Note: Cap-panel interconnect wiring specification according to UL508 75° C Table.

Note: To prevent flexing or bending of the coil windings attached to SWG reactor use appropriate strain relief to prevent stress on terminals. For flat copper terminal tabs, use two wrenches to tighten customer provided cable mounting hardware.

Note: Refer to reference drawings on MTE website for termination wire ranges:

www.mtecorp.com/sinewave-literature-documentation/

Basic Schematic Diagram

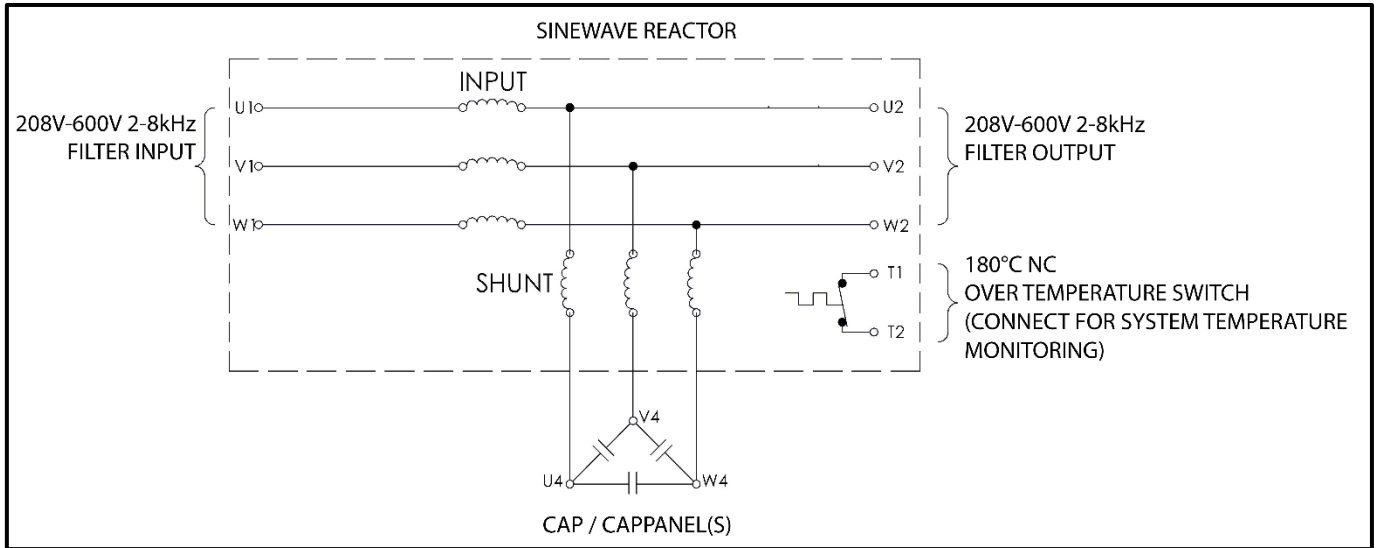

Figure 3-1: Basic Schematic Diagram

Modular Unit Interconnection Diagram

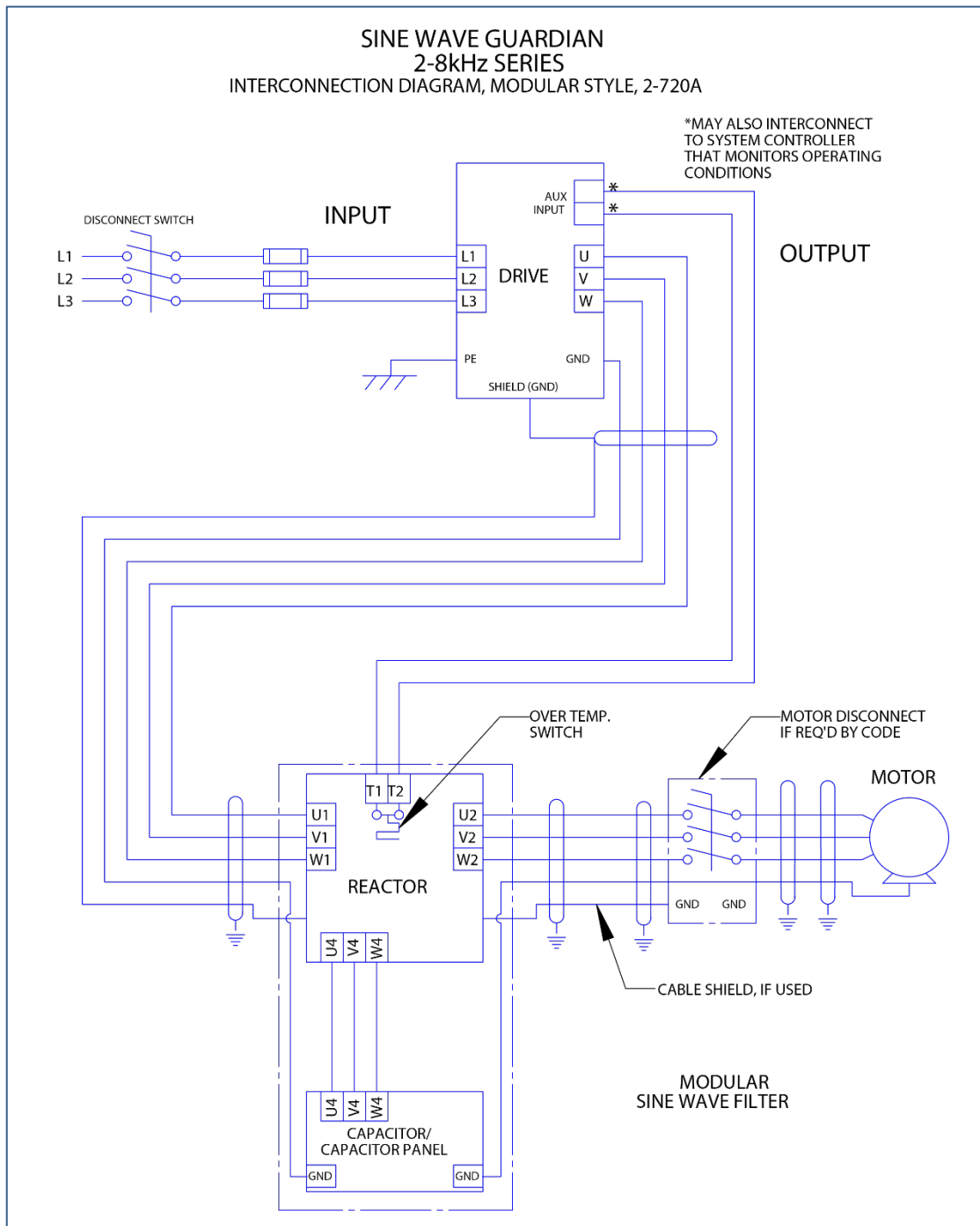

Figure 3-2: Modular Interconnection

Enclosed Unit Interconnection Diagram

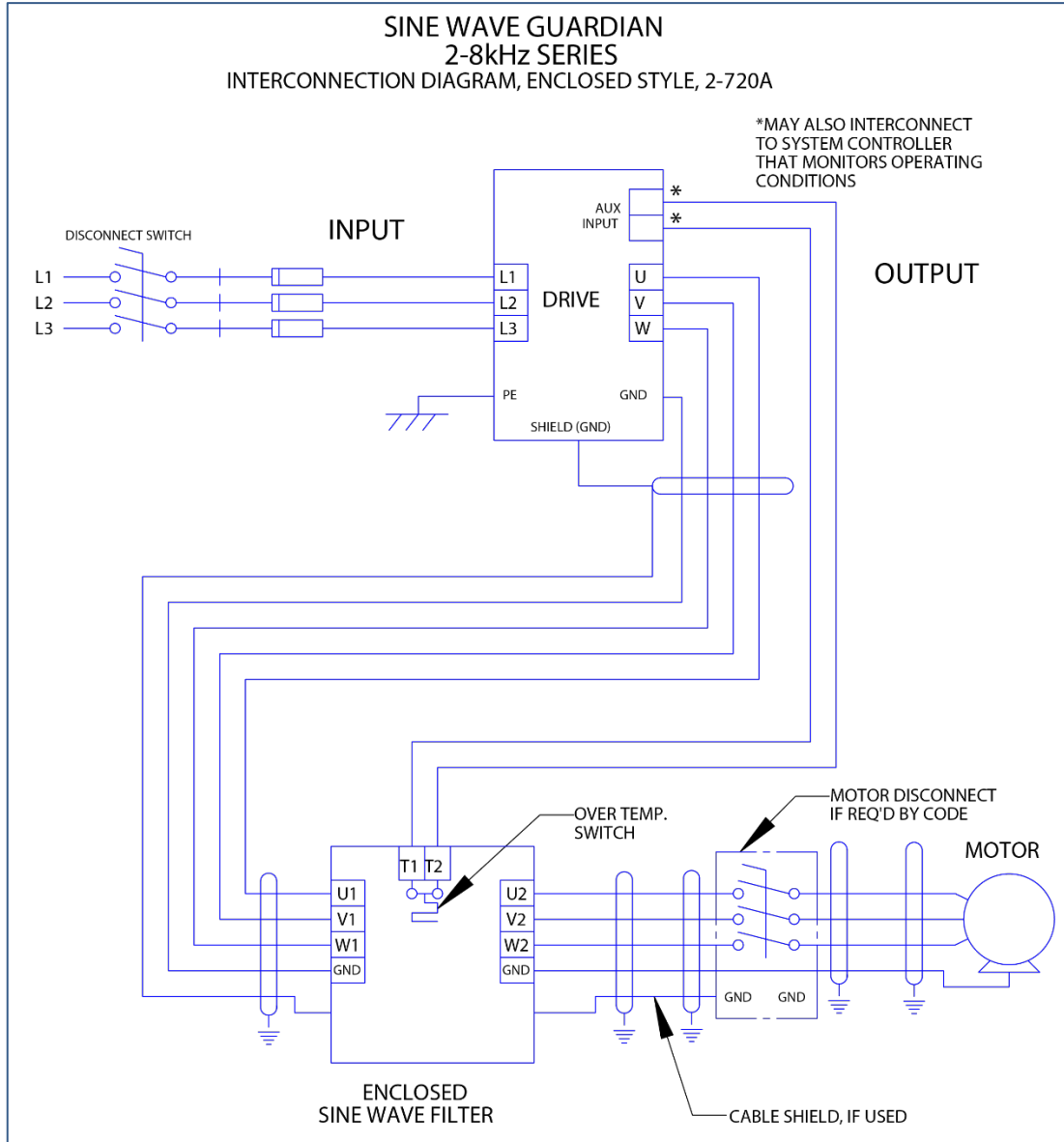

Figure 3-3: Enclosed Interconnection

Isolation Transformer Diagram

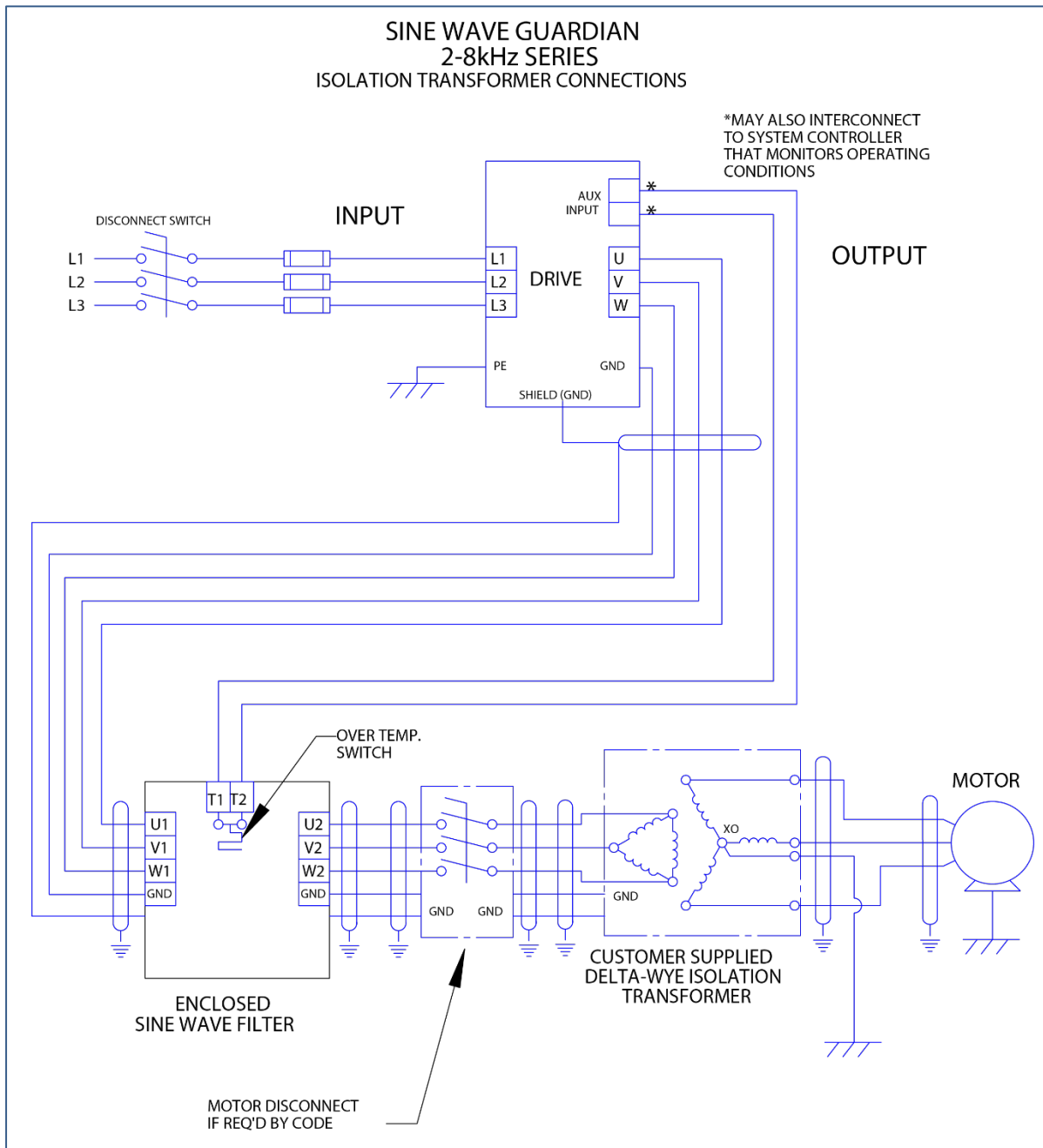

Figure 3-4: Isolation Transformer

Torque Ratings 208V-240V

Table 3-2: Torque Ratings 208V-240V

Filter Rating (Amps)	SWG Terminals			Cap-panel Terminals U4-V4-W4		
	Input /Output Power U1-V1-W1 / U2-V2-W2		U4-V4-W4 interconnect Cap-panel	Capacitor/ Cap-panel Part Number	Minimum Interconnect Wire Gauge (AWG)	Terminal Torque (in-lbs.)
	Recommended Minimum Wire Size (AWG)	Terminal Torque (in-lbs.)	Terminal Torque (in-lbs.)			
9	14	16	16	CAP-507SW	14	23
12	14	16	16	CAP-508SW	14	23
17	12	16	16	CAP-510SW	14	23
22	10	16	16	CAP-528SW	14	23
30	8	16	16	CAP-513SW	14	23
45	8	16	16	CAP-531SW	14	23
55	6	N/A	16	CAP-515SW	14	23
70	6	N/A	16	CAP-537SW	14	23
85	4	N/A	16	CAP-538SW	12	23
110	2	N/A	N/A	CAP-539SW	10	23
135	1	N/A	N/A	CAP-537SW	10	23
160	4 (2x) or 2/0	N/A	N/A	CAP-541SW	8	23
200	3 (2x) or 1/0	N/A	N/A	CAP-542SW	8	23
250	1 (2x) or 250K CMIL	N/A	N/A	CAP-538SW	8	23
			N/A	CAP-541SW	8	23
320	2/0 (2x)	N/A	N/A	CAPPANEL-185	4	60

Torque Ratings 380V-480V

Table 3-3: Torque Ratings 380-480V

Filter Rating (Amps)	SWG Terminals			Cap-panel Terminals U4-V4-W4		
	Input /Output Power U1-V1-W1 / U2-V2-W2		U4-V4-W4 interconnect Cap-panel	Capacitor/ Cap-panel Part Number	Minimum Interconnect Wire Gauge (AWG)	Terminal Torque (in-lbs.)
	Recommended Minimum Wire Size (AWG)	Terminal Torque (in-lbs.)	Terminal Torque (in-lbs.)			
2	14	16	16	CAP-501SW	14	23
3	14	16	16	CAP-502SW	14	23
5	14	16	16	CAP-503SW	14	23
7	14	16	16	CAP-504SW	14	23
9	14	16	16	CAP-505SW	14	23
12	14	16	16	CAP-506SW	14	23
17	12	16	16	CAP-507SW	14	23
22	10	16	16	CAP-508SW	14	23
27	10	N/A	16	CAP-509SW	14	23
35	8	N/A	16	CAP-510SW	14	23
45	8	16	16	CAP-511SW	14	23
55	6	N/A	16	CAP-512SW	14	23
65	6	N/A	16	CAP-513SW	14	23
80	4	N/A	N/A	CAP-514SW	12	23
110	2	N/A	N/A	CAP-515SW	10	23
130	1	N/A	N/A	CAP-516SW	10	23
160	4 (2x) or 2/0	N/A	N/A	CAPPANEL-604(C)	8	60
200	3 (2x) or 1/0	N/A	N/A	CAPPANEL-605(C)	8	60
250	1 (2x) or 250K CMIL	N/A	N/A	CAPPANEL-606(C)	6	60
305	2/0 (2x)	N/A	N/A	CAPPANEL-623(C)	4	60
365	3/0 (2x)	N/A	N/A	CAPPANEL-608(C)	4	60
415	4/0 (2x)	N/A	N/A	CAPPANEL-609(C)	3	60
515	300 MCM (2)	N/A	N/A	CAPPANEL-610(C)	2	60
600	400K CMIL (2x)	N/A	N/A	CAPPANEL-611(C)	1/0	60
720	500K CMIL (2x)	N/A	N/A	CAPPANEL-608(C)	4	60
			N/A	CAPPANEL-611(C)	1/0	60

Filter Rating (Amps)	SWG Terminals			Cap-panel Terminals U4-V4-W4		
	Input /Output Power U1-V1-W1 / U2-V2-W2		U4-V4-W4 interconnect Cap-panel	Capacitor/ Cap-panel Part Number	Minimum Interconnect Wire Gauge (AWG)	Terminal Torque (in-lbs.)
	Recommended Minimum Wire Size (AWG)	Terminal Torque (in-lbs.)	Terminal Torque (in-lbs.)			
850	500K CMIL (3x)	N/A	N/A	CAPPANEL-572(C)	2	60
			N/A	CAPPANEL-619(C)	1	
1,000	600K CMIL (3x)	N/A	N/A	CAPPANEL-623(C)	1/O	60
			N/A	CAPPANEL-624(C)	1	
1,200	800K CMIL (3x)	N/A	N/A	CAPPANEL-611(C)	1	60
1,500	1000K CMIL	N/A	N/A	CAPPANEL-577(C)	1/O	60

Torque Ratings 600V

Table 3-4: Torque Ratings 600V



Filter Rating (Amps)	SWG Terminals			Cap-panel Terminals U4-V4-W4		
	Input /Output Power U1-V1-W1 / U2-V2-W2		U4-V4-W4 interconnect Cap-panel	Capacitor/ Cap-panel Part Number	Minimum Interconnect Wire Gauge (AWG)	Terminal Torque (in-lbs.)
	Recommended Minimum Wire Size (AWG)	Terminal Torque (in-lbs.)	Terminal Torque (in-lbs.)			
2	14	16	16	CAP-534SW	14	23
3	14	16	16	CAP-535SW	14	23
5	14	16	16	CAP-518SW	14	23
7	14	16	16	CAP-520SW	14	23
9	14	16	16	CAP-519SW	14	23
12	14	16	16	CAP-522SW	14	23
17	12	16	16	CAP-523SW	14	23
22	10	16	16	CAP-524SW	14	23
27	10	16	16	CAP-525SW	14	23
35	8	16	16	CAP-526SW	14	23
45	8	16	16	CAP-527SW	14	23
55	6	16	16	CAP-528SW	14	23
65	6	16	16	CAP-529SW	14	23
80	4	16	16	CAP-530SW	12	23
110	2	16	16	CAP-531SW	10	23
130	1	N/A	N/A	CAP-532SW	8	23
160	4 (2x) or 2/0	N/A	N/A	CAP-533SW	8	23
200	3 (2x) or 1/0	N/A	N/A	CAPPANEL-157	4	60
250	1 (2x) or 250K CMIL	N/A	N/A	CAPPANEL-161	4	60
305	2/0 (2x)	N/A	N/A	CAPPANEL-161	4	60
			N/A	CAPPANEL-162	14	23
365	3/0 (2x)	N/A	N/A	CAPPANEL-161	4	60
			N/A	CAPPANEL-163	10	23
415	4/0 (2x)	N/A	N/A	CAPPANEL-161	4	60
			N/A	CAPPANEL-163	10	23
515	300 MCM (2x)	N/A	N/A	CAPPANEL-157	4	60
			N/A	CAPPANEL-161	4	

Filter Rating (Amps)	SWG Terminals			Cap-panel Terminals U4-V4-W4		
	Input /Output Power U1-V1-W1 / U2-V2-W2		U4-V4-W4 interconnect Cap-panel	Capacitor/ Cap-panel Part Number	Minimum Interconnect Wire Gauge (AWG)	Terminal Torque (in-lbs.)
	Recommended Minimum Wire Size (AWG)	Terminal Torque (in-lbs.)	Terminal Torque (in-lbs.)			
600	400K CMIL (2x)	N/A	N/A	CAPPANEL-161	4	60
			N/A	CAPPANEL-164	12	23
720	500K CMIL (2x)	N/A	N/A	CAPPANEL-161	4	60
			N/A	CAPPANEL-157	4	60
			N/A	CAP-525SW	14	23
865	500K CMIL (3x)	N/A	N/A	CAPPANEL-161	4	60
			N/A	CAPPANEL-157	4	
1,000	600K CMIL (3x)	N/A	N/A	CAPPANEL-161	4	60
			N/A	CAPPANEL-157	4	
1,200	800K CMIL (3x)	N/A	N/A	CAPPANEL-161	4	60
			N/A	CAP-533SW	8	23
1,500	1000K CMIL	N/A	N/A	CAPPANEL-161	4	60
			N/A	CAP-532SW	8	23

4. START UP

Startup Checklist



Before startup, observe the following warnings and instructions:

 WARNING	<p>Internal components of the filter are at line potential when the filter is connected to the drive. This voltage is extremely dangerous and may cause death or severe injury if you come in contact with it.</p>
	<p>Remove all power to the SineWave Guardian filter in compliance to standardized 26 CFR 1920.147 lockout/tagout policies. After removing power, allow at least five minutes to elapse and verify that the capacitors have discharged to a safe level before contacting internal components. Connect a DC voltmeter across the capacitor terminals and ensure that the voltage is at a safe level.</p>
	<p>Use extreme caution to avoid contact with line voltage when checking for power. INJURY OR DEATH MAY RESULT IF SAFETY PRECAUTIONS ARE NOT OBSERVED.</p>
 Caution	<p>Prior to start up; confirm the drive operation mode is property set. Please consult drive manual/manufacturer to configure proper parameters. Failure to do so may result in failure of drive or filter components.</p>
	<p>Damage to the filter may occur if the output frequency is not set between 2 kHz and 8 kHz. Optimum output frequency is 2kHz to 3kHz.</p>
	<p>MTE recommends 10 seconds as an initial starting point for motor ramp time and that customers examine the actual inrush and ratings of their drive system. Inrush current seen at the drive from the filter that can easily be overcome by changing the motor ramp time.</p>

Sequence of Operation

1. Read and follow safety precautions.
2. After installation, ensure that:
 - All filter ground terminals are connected to ground.
 - Power wiring to the utility, drive, filter and motor is in accordance with the power wiring connection diagrams shown in installation instructions section.
3. Check that moisture has not condensed on the filter components. If moisture is present, do not proceed with startup until the moisture has been removed.
4. Disconnect filter output terminals from the motor.
5. Set the drive switching frequency between 2 kHz and 8 kHz. Refer to the drive user manual.
6. Connect filter temperature safety overload switch into the control circuit so that the drive will shut down in an overload situation.
7. Confirm that drive voltage is present at the input terminals (U1, V1, W1) of the filter.
8. Confirm that motor voltage is present at the output terminals (U2, V2, W2) of the filter.
9. Connect the filter output to the motor.
10. Refer to the drive user manual for the drive startup procedure. Observe all safety instructions in the drive user manual.
11. Contact factory if the drive requires filter inductors and capacitor values for SineWave set-up.

5. TROUBLESHOOTING

 WARNING	<p>When properly installed, this equipment has been designed to provide maximum safety for operating personnel. However, hazardous voltages and elevated temperatures exist within the confines of the enclosure. Servicing should therefore be performed by qualified personnel only and in accordance with OSHA Regulations.</p>
 Caution	<p>High voltage is used in the operation of this filter. Use Extreme caution to avoid contact with high voltage when operating, installing or repairing this filter. INJURY OR DEATH MAY RESULT IF SAFETY PRECAUTIONS ARE NOT OBSERVED.</p> <p>After removing power, allow at least five minutes to elapse and verify that the capacitors have discharged to a safe level before contacting internal components. Connect a DC voltmeter across the capacitor terminals or terminals U1, V1 or V1, W1 and ensure that the voltage is at a safe level.</p>

To aid in troubleshooting, refer to the following interconnect diagrams and troubleshooting guide:

Figure 3-2: Modular Interconnection (p12)

Figure 3-3: Enclosed Interconnection (p13)

Figure 3-4: Isolation Transformer (p14)

Table 5-2: Troubleshooting Guide (p24)

Table 5-1: Performance Specifications

Service Load Condition	Conventional 3 phase motors operating in volts per Hertz mode Standard step-up transformer optional
Input Voltage	208V – 600V +/- 10%
Harmonic Voltage Distortion	5% maximum @ 2kHz
Inverter Switching Frequency	2kHz – 8kHz (Optimal performance achieved @ 2kHz)
Inverter Operating Frequency	6Hz to 75Hz; >75Hz to 120Hz with derating
Maximum Ambient Temperature	-40C to +60C Modular Filter; -40C to +55C Enclosed Filter -40C to +90C Storage
Insulation System	Class N (200° C)
Insertion Loss (Voltage)	6% maximum @ 60Hz
Efficiency	>98%
Altitude without derating	3,300 feet above sea level
Maximum Motor Lead Length	15,000 feet
Relative Humidity	0% to 95% non-condensing
Current Rating	100% RMS Continuous; 150% for 1 minute Intermittent

SineWave Guardian Motor Protection Filter Field Checks

1. Read and understand the [SineWave Guardian Technical Reference Manual](#).
2. Disconnect all power and remove input power wiring from U1, V1, W1 terminals.
3. Remove VFD drive power connections from filter terminals U2, V2, W2 and any contactor or temperature switch wiring. (For filters using control transformers: remove power fuses on top of transformer.)
4. Visually inspect filter terminals and wiring lugs for signs of heat and corrosion. **Contact factory if any wires appear to be missing or cut!**
5. Inspect the U4, V4, W4 capacitor interconnect terminals and wiring.
6. Visually inspect all capacitors for signs of case deformation, bowing of the top, leaking oil or terminal damage. Note the CAP- # and date code of any damaged capacitors.
7. Using a multi meter set to read 100K ohms check:
 - a. Phase to phase U1-V1-W1-U1 (mechanically activate contactor if present) after reactor and caps charge reading should be about 40K (total equivalent bleeder resistance value) and should be the same for each phase. Open circuit or very low readings indicate a problem.
 - b. Phase to chassis U1- case, V1-case, W1- case; low readings indicate a ground fault problem.
8. Ensure the “disconnect” is safe, then wire the utility power to U1, V1, W1.
9. Apply power and verify that proper output voltage is present on U2, V2, and W2.
10. Using a clamp on amp meter read the filter input current:
 - a. Readings will be 0.5 of the capacitor current listed in the [SineWave Guardian Technical Reference Manual](#) – pages 6 – 8; mechanically activate the contactor if the filter is equipped with one. Readings should be the same (+/- 5%) for all phase currents; **contact the factory if currents are out of tolerance!**
 - b. Open contactor readings will show zero current for all phases.
11. Disconnect filter power and wire the VFD to U2, V2, and W2 as well as any control wiring to the filter contactor or temperature switch. Replace any control transformer fuses. Follow the drive power start-up guidelines in the drive manufacturer’s user manual.

Table 5-2: Troubleshooting Guide

PROBLEM:	Drive Overcurrent Fault
Possible cause:	Motor ramp-up time too short.
Solution:	MTE suggests a ramp time of >5-10 seconds. Consult drive manufacturers manual to configure proper parameters.
Possible cause:	Failed or incorrect wiring
Solution:	Verify all field and product wiring is correct.
Possible cause:	Parameter compatibility.
Solution:	Consult drive manufacturers manual for operating drive with a motor protection filter.
Possible cause:	Filter, Drive, Motor current ratings compatible.
Solution:	Verify the filter and motor are properly sized for the application.
Possible cause:	Drive operation mode is not properly set.
Solution:	Consult drive manufacturers manual to configure proper parameters.
Possible cause:	Motor winding fault.
Solution:	Verify motor windings and hi-pot is necessary.
Possible cause:	Cable failure.
Solution:	Verify cable continuity and insulation.
PROBLEM:	Excessive Filter Noise
Possible cause:	Mismatched motor rating.
Solution:	Verify the filter is properly sized for the application.
Possible cause:	Capacitors disconnected or improperly wired.
Solution:	Verify the proper connection of the capacitors.
Possible cause:	Carrier frequency less than 2 kHz.
Solution:	Verify the carrier frequency is at least 2 kHz.
PROBLEM:	Temperature Switch Open
Possible cause:	Mismatched motor rating.
Solution:	Verify the filter is properly sized for the application.
Possible cause:	Capacitors disconnected or improperly wired.
Solution:	Verify the proper connection of the capacitors.
Possible cause:	Carrier frequency less than 2 kHz.
Solution:	Verify the carrier frequency is at least 2 kHz.
Possible cause:	Excessive ambient temperature.
Solution:	Ensure filter is operating within specified ambient temperature below 60° C.
PROBLEM:	Motor will not turn.
Possible cause:	No power.
Solution:	Check fuses or breakers for proper input power.
Possible cause:	Motor incorrectly wired.
Solution:	Check for wiring faults.
Possible cause:	Locked rotor motor load.
Solution:	Check motor load.
Possible cause:	Drive fault.
Solution:	Consult drive manufacturers manual.
Possible cause:	Capacitors disconnected or improperly wired.
Solution:	Verify the proper connection of the capacitors.
Possible cause:	Overloaded motor.
Solution:	Verify the motor is properly sized for the application.