

# High Frequency SineWave Guardian™

380V – 480V

## INSTALLATION GUIDE

FORM: SHF-IG-E  
REL. January 2018  
REV. 002  
© 2018 MTE Corporation



High Voltage! Only a qualified electrician can carry out the electrical installation of this filter.

### Quick Reference

<b>1</b>	How to Install	Pages 6 – 12
<b>2</b>	Startup/Troubleshooting	Pages 13 – 16

## TABLE OF CONTENTS

- 1. WARNINGS .....3**
  - WARNINGS AND CAUTIONS .....3
  - GENERAL SAFETY INSTRUCTIONS .....4
- 2. INTRODUCTION .....5**
  - RECEIPT & REPAIR STATEMENT .....5
  - WARRANTY .....5
- 3. HOW TO INSTALL .....6**
  - INSTALLATION CHECKLIST .....6
  - GROUNDING .....7
  - POWER WIRING CONNECTION .....8
  - BASIC SCHEMATIC DIAGRAM .....9
  - OPEN PANEL UNIT INTERCONNECTION DIAGRAM .....10
  - ISOLATION TRANSFORMER DIAGRAM.....11
  - TORQUE RATINGS .....12
- 4. START UP .....13**
  - STARTUP CHECKLIST .....13
- 5. TROUBLESHOOTING.....15**

### List of Figures

- Figure 3-1: Basic Schematic Diagram ..... 9
- Figure 3-2: Open Panel Interconnection.....10
- Figure 3-3: Isolation Transformer .....11



### List of Tables

- Table 3-1: Over Temperature Switch ..... 7
- Table 3-2: Torque Ratings .....12
- Table 5-1: Performance Specifications.....15
- Table 5-2: Troubleshooting Guide .....16



# 1. WARNINGS

## Warnings and Cautions



There are two types of warnings in this manual:

 <b>WARNING</b>	<p>WARNING describes situations that can lead to serious faults, physical injuries, or even death.</p>
 <b>Caution</b>	<p>Caution describes situations that can lead to malfunction or possible equipment damage.</p>

The following symbols are used in this manual.

 <b>WARNING</b>	<p>High Voltage Warning: warns of situations that dangerously high voltage is involved. Failure to use proper precautions may lead to serious injury or even death.</p>
 <b>WARNING</b>	<p>General Warning: warns of situations that can result in serious injury or death if proper precautions are not used.</p>
 <b>Caution</b>	<p>General Caution: identifies situations that could lead to malfunction or possible equipment damage.</p>

### General Safety Instructions

 <b>WARNING</b>	<p><b>High Voltage! Only a qualified electrician can carry out the electrical installation of this filter.</b></p> <p>High voltage is used in the operation of this filter. Use extreme caution to avoid contact with high voltage when operating, installing or repairing this filter. <b>Injury or death may result if safety precautions are not observed.</b></p>
 <b>WARNING</b>	<p>The opening of the branch circuit protective device may be an indication that a fault current has been interrupted. To reduce the risk of fire or electrical shock, current-carrying parts and other components of the filter should be examined and replaced if damaged.</p> <p>An upstream disconnect/protection device must be used as required by the National Electrical Code (NEC) or governing authority.</p> <p>Even if the upstream disconnect/protection device is open, the drive down stream of the filter may feedback high voltage to the filter. The drive safety instructions must be followed. <b>Injury or death may result if safety precautions are not observed.</b></p> <p>The filter must be grounded with a grounding conductor connected to all grounding terminals. Open panel filters must have reactor grounded through a 2"x2" area cleaned of paint and varnish on lower mounting bracket.</p> <p>Only spare parts obtained from MTE Corporation or an authorized MTE distributor can be used.</p> <p>After removing power, allow at least five minutes to elapse and verify that the capacitors have discharged to a safe level before contacting internal components. Connect a DC voltmeter across the capacitor terminals and ensure that the voltage is at a safe level.</p>
 <b>Caution</b>	<p>Loose or improperly secured connections may damage or degrade filter performance. Visually inspect and secure all electrical connections before power is applied to the filter.</p> <p>Prior to start up; confirm the drive operation mode is property set (Volts per Hertz). Please consult drive manual/manufacturer to configure proper parameters. Failure to do so may result in failure of drive or filter components.</p> <p>Damage to the filter may occur if the output frequency is not set between 4.8 kHz and 8 kHz. Optimum output frequency is 5 kHz.</p> <p>Over speeding a motor can cause it to break. Motor must be rated to run above 60 Hz.</p>

## 2. INTRODUCTION

The purpose of the manual is to aid in the proper installation of the High Frequency SineWave Guardian.

For most current product information, including technical reference manual, please refer to website:

[www.mtecorp.com/high-frequency-sinewave-guardian/](http://www.mtecorp.com/high-frequency-sinewave-guardian/)

This manual is intended for use by personnel experienced in the operation and maintenance of drives. Because of the high voltages required by the filter, drive and the potential dangers presented by rotating machinery, it is essential that all personnel involved in the operation and maintenance of this filter know and practice the necessary safety precautions for this type of equipment. Personnel should read and understand the instructions contained in this manual before installing, operating or servicing the filter and drive to which it is connected.

### Receipt & Repair Statement

#### Upon Receipt of this Filter:

The High Frequency SineWave Guardian Motor Protection Filter has been subjected to demanding factory tests before shipment. Carefully inspect the shipping container for damage that may have occurred in transit. Then unpack the filter and carefully inspect for any signs of damage. Save the shipping container for future transport of the filter.

**In the event of damage, please contact and file a claim with the freight carrier involved immediately.**

If the equipment is not going to be put into service upon receipt, cover and store the filter in a clean, dry location. After storage, ensure that the equipment is dry and that no condensation or dirt has accumulated on the internal components of the filter before applying power.

#### Repair/Exchange Procedure

MTE Corporation requires a Return Material Authorization Number and form before we can accept any filters that qualify for return or repair. If problems or questions arise during installation, setup, or operation of the filter, please contact MTE for assistance at:

Toll Free: 1-800-455-4MTE (1-800-455-4683)

International Tel: +1- 262-253-8200



Fax: +1-262-253-8222

### Warranty

Three years from the date of shipment. See [www.mtecorp.com](http://www.mtecorp.com) for details.

### 3. HOW TO INSTALL

#### Installation Checklist

 <b>WARNING</b>	<p>Prior to installation, please refer to all general warnings on page 4. Failure to practice this can result in body injury!</p>
	<p>Input and output wiring to the filter should be performed by authorized personnel in accordance with NEC and all local electrical codes and regulations.</p>
 <b>WARNING</b>	<p>The filter is designed for use with copper conductors with a minimum temperature rating of 75 degrees C.</p>

High Frequency SineWave Guardian Filters are supplied in the following mechanical configuration:

- Modular: Modular units consist of a reactor and one or more capacitor panel assemblies referred to as cap-panels on drawings and diagrams. Additional wiring between the reactor and capacitor/capacitor panel is required by customer.

Modular units are designed for mounting within the customer’s enclosure.

The capacitor panel must be located in the lowest temperature regions of the enclosure – generally toward the bottom and away from high temperature components.

Include the power dissipation of the filter along with all the other components located in the enclosure to determine the internal temperature rise and cooling requirements of the enclosure.

Refer to Article 430 Table 430.91 of the National Electrical code for the selection of the appropriate enclosure Type Number for your application.

## Grounding

 <b>WARNING</b>	<b>The filter must always be grounded with a grounding conductor connected to ground terminals.</b>
	<b>For open panel units, ensure a 2" x 2" area is cleaned of paint and varnish on lower mounting bracket for ground connection.</b>

**NOTE:** For cable shield grounding follow the drive manufactures recommendations.

### Grounding and Ground Fault Protection

Due to high leakage currents associated with variable frequency drives, ground fault protective devices do not necessarily operate correctly when placed ahead of a SineWave Filter feeding a drive. When using this type of device, its function should be tested in the actual installation.

### Location & Spacing

Modular High Frequency SineWave Guardian filters are designed for mounting within the customer's enclosure. When determining the internal temperature rise and cooling requirements of the enclosure, include the power dissipation of the filter along with all the other components located in the panel. A general guideline is to allow a side clearance of four (4) inches and a vertical clearance of six (6) inches for proper heat dissipation and access within the enclosure. Clearances may be less if proper ventilation exists. Filter components must operate within temperatures specified in this manual or filter operating life will be compromised. Also, be aware of minimum electrical clearances as defined by the appropriate system safety standard(s). These filters generate heat and should be positioned away from heat sensitive components. Avoid locations where the filter would be subjected to excessive vibrations. Locate the filter as close to the inverter as possible.

### Over Temperature Interlock

An over temperature interlock circuit should be used in conjunction with thermal switch to turn off the drive to prevent filter damage due to abnormal operating conditions. The temperature switch is normally closed and will open when an internal reactor temperature of 180°C is reached. See Table 3-1 below for contact rating information and the drive user manual for interconnection information.

**Table 3-1: Over Temperature Switch**

<i>NC Switch</i> opens at 180 Deg. +/- 5 Deg. C		
<b>Current Amps</b>	<b>Voltage</b>	<b>Contact Load</b>
6	120 AC	Resistive Loads
3	120 AC	Inductive Loads
3	240 AC	Resistive Loads
2.5	240 AC	Inductive Loads
8	12 VDC	Resistive Loads
4	24 VDC	Resistive Loads

MTE highly recommends the use of the over temperature switch to prevent damage to the filter in rare instances of overheating from abnormal operating conditions

## Power Wiring Connection

 <b>WARNING</b>	<p><b>Input and output power wiring to the filter should be performed by authorized personnel in accordance with the NEC and all local electrical codes and regulations.</b></p> <p><b>Cable lugs and mounting hardware are provided by the customer.</b></p>
	<p><b>Any extremely low or high resistance readings indicate miswiring and may result in damage to filter components if not corrected.</b></p>

Verify that the rating of the filter is compatible with the drive to which it is to be connected. Follow all detailed drive manufacturer installation and safety instructions. Drive and load cable selection / placement should be in accordance with the requirements of the NEC and all local electrical codes and regulations.

The typical interconnection diagrams that follow are shown for a motor load but the load can be either a motor or a transformer.

- For panel mounted filter applications, interconnection between the filter, its power source, the cap-panels, and the drive is shown in Figure 3-2 (p10).
- For isolation transformer connections between the filter, motor and the drive is shown in Figure 3-3 (p11).

Wire gauge range and terminal torque requirements as well as selecting conductors that interconnect the reactor and capacitor assemblies are shown in Table 3-2 (p12).

Refer to the drive user manual for instructions on interconnecting the drive and motor and the correct start-up procedures for the drive.

The filter is designed for use with copper conductors with a minimum temperature rating of 75 degrees C.

### Wiring Checks

Using Figure 3-1 (p9), visually check the wired components to confirm, verify, and correct wiring. Then, with a multi meter check phase to phase isolation using the 100 K ohm range. The multi meter will read the parallel equivalent of the bleeder resistors after the capacitors initially charge. All phase to phase resistance values should be the same.

#### Check for the Following Faults:

- Capacitor shorted
- Capacitor bus not connected
- Capacitor bus to chassis short
- Paralleling wiring errors



**Basic Schematic Diagram**

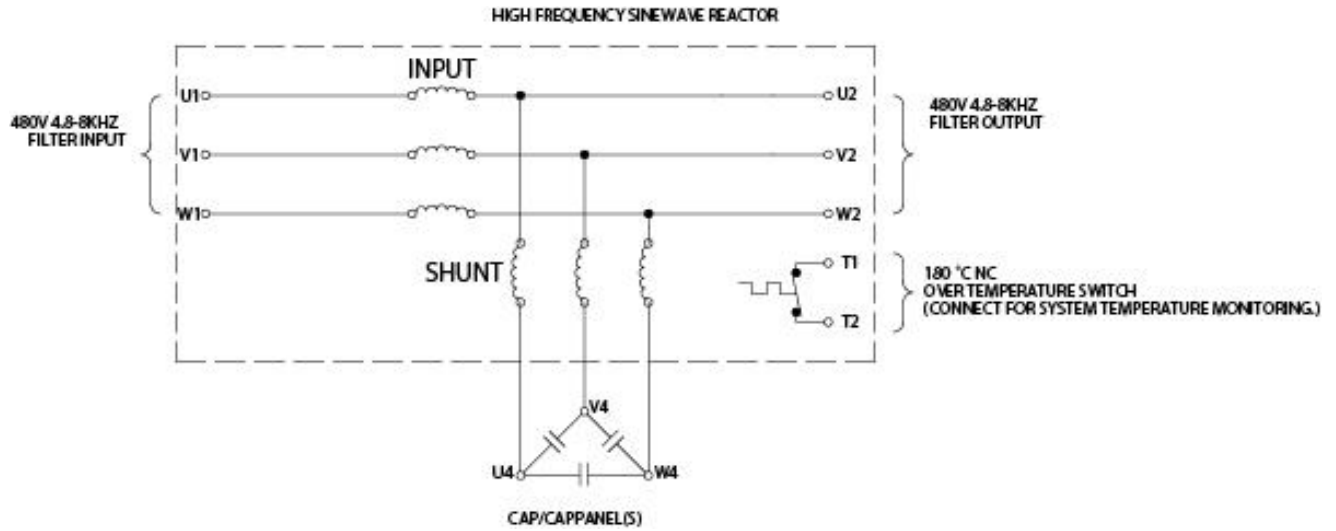

**Figure 3-1: Basic Schematic Diagram**

## Open Panel Unit Interconnection Diagram

SINE WAVE HIGH FREQUENCY  
4.8-8kHz SERIES  
INTERCONNECTION DIAGRAM, MODULAR STYLE, 80-600A

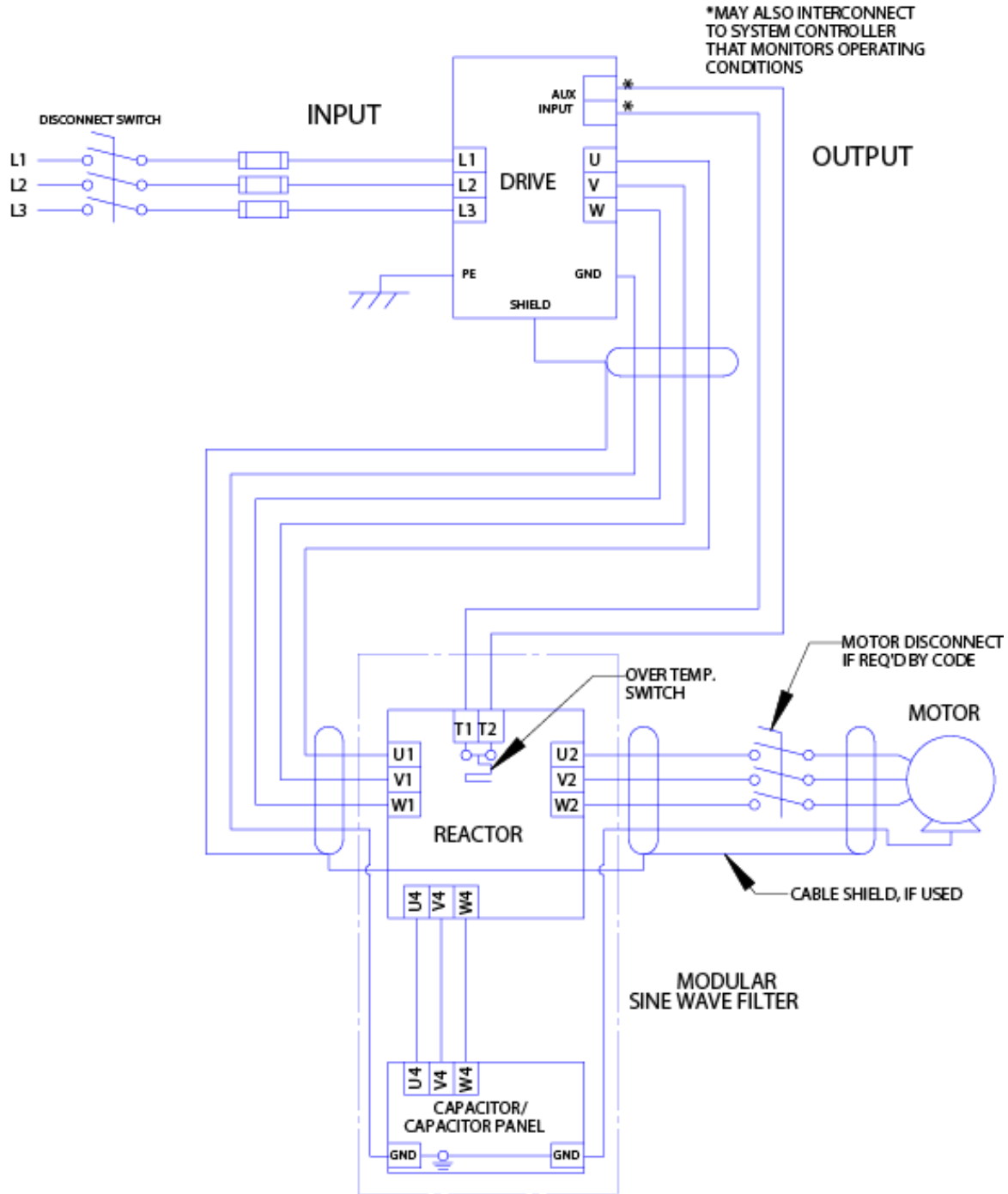
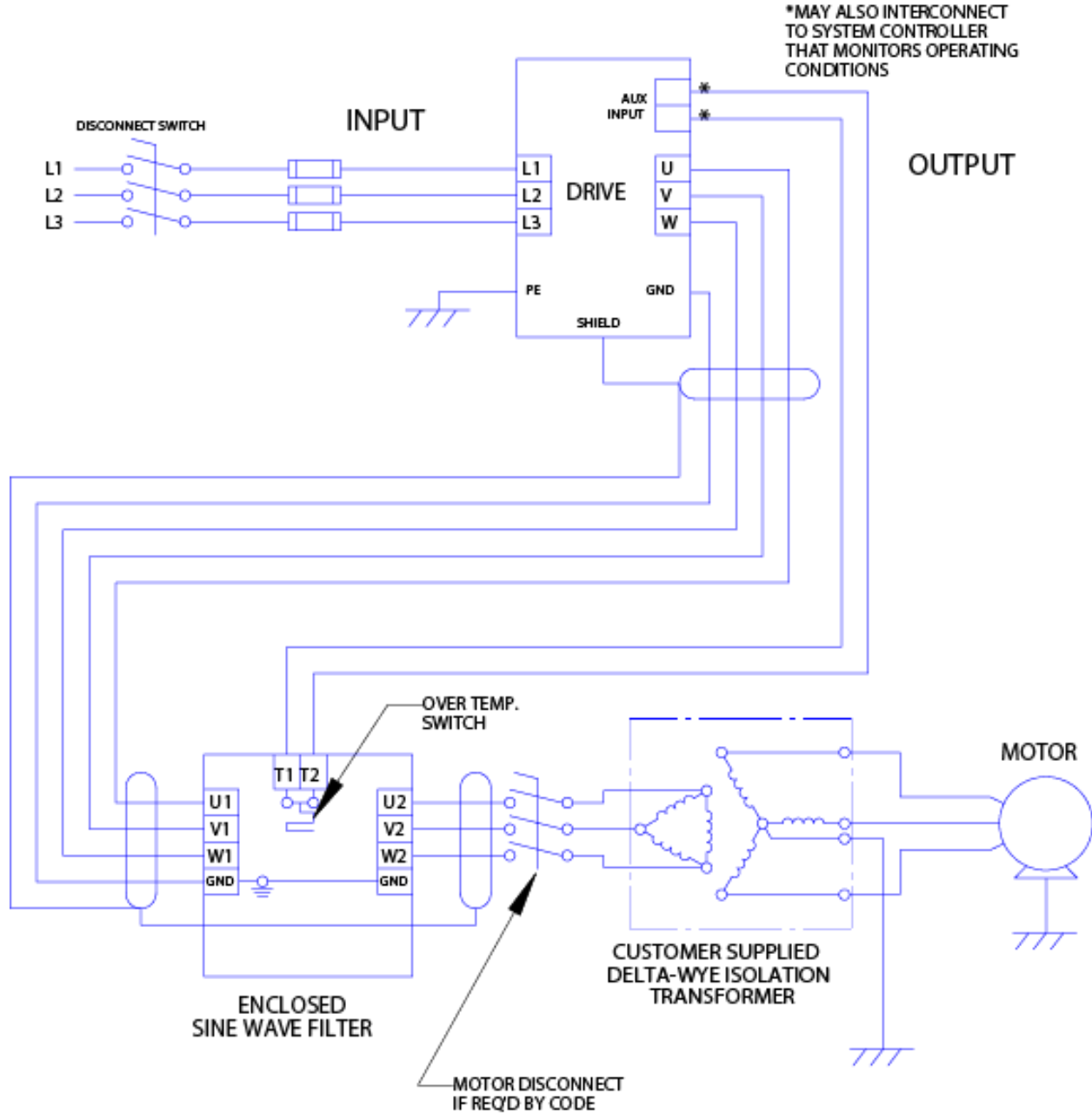

Figure 3-2: Open Panel Interconnection

**Isolation Transformer Diagram**

SINE WAVE HIGH FREQUENCY  
4.8-8kHz SERIES  
ISOLATION TRANSFORMER CONNECTIONS



**Figure 3-3: Isolation Transformer**

## Torque Ratings

Table 3-2: Torque Ratings

Filter Rating (Amps)	SWG Terminals			Cap-panel Terminals U4-V4-W4		
	Input /Output Power U1-V1-W1 / U2-V2-W2		U4-V4-W4 interconnect Cap-panel	Cap-panel Part Number	Minimum Interconnect Wire Gauge (AWG)	Terminal Torque (in-lbs.)
	Recommended Minimum Wire Size (AWG)	Terminal Torque (in-lbs.)	Terminal Torque (in-lbs.)			
80	4	N/A	N/A	CAPPANEL-006	10	60
110	2	N/A	N/A	CAPPANEL-007	8	60
130	1	N/A	N/A	CAPPANEL-008	8	60
160	4 (2x) or 2/0	N/A	N/A	CAPPANEL-009	6	60
200	3 (2x) or 1/0	N/A	N/A	CAPPANEL-003	4	60
250	1 (2x) or 250K CMIL	N/A	N/A	CAPPANEL-002	4	60
305	2/0 (2x)	N/A	N/A	CAPPANEL-002	3	60
415	4/0 (2x)	N/A	N/A	CAPPANEL-002 (2X)	4 each	60
515	300 MCM (2x)	N/A	N/A	CAPPANEL-002, 003 (2X)	4 each	60
600	400K CMIL	N/A	N/A	CAPPANEL-002, 003 (2X)	4 each	60

**Note:** Cap-panel interconnect wiring specification according to UL508 75° C Table.

**Note:** To prevent flexing or bending of the coil windings attached to High Frequency SWG reactor use appropriate strain relief to prevent stress on terminals. For flat copper terminal tabs, use two wrenches to tighten customer provided cable mounting hardware.

**Note:** Refer to reference drawings on MTE website for termination wire ranges:



[www.mtecorp.com/high-frequency-sinewave-guardian/high-frequency-sinewave-guardian-literature-documentation/](http://www.mtecorp.com/high-frequency-sinewave-guardian/high-frequency-sinewave-guardian-literature-documentation/)

## 4. START UP

### Startup Checklist

#### Safety Precautions



Before startup, observe the following warnings and instructions:

 <b>WARNING</b>	<p><b>Internal components of the filter are at line potential when the filter is connected to the drive. This voltage is extremely dangerous and may cause death or severe injury if you come in contact with it.</b></p>
	<p><b>Remove all power to the SineWave Guardian filter in compliance to standardized 26 CFR 1920.147 lockout/tagout policies. After removing power, allow at least five minutes to elapse and verify that the capacitors have discharged to a safe level before contacting internal components. Connect a DC voltmeter across the capacitor terminals and ensure that the voltage is at a safe level.</b></p>
	<p><b>Use extreme caution to avoid contact with line voltage when checking for power. INJURY OR DEATH MAY RESULT IF SAFETY PRECAUTIONS ARE NOT OBSERVED.</b></p>
 <b>Caution</b>	<p><b>Prior to start up; confirm the drive operation mode is property set (Volts per Hertz). Please consult drive manual/manufacturer to configure proper parameters. Failure to do so may result in failure of drive or filter components.</b></p>
	<p><b>Damage to the filter may occur if the output frequency is not set between 4.8 kHz and 8 kHz. Optimum output frequency is 5 kHz.</b></p>
	<p><b>MTE recommends 10 seconds as an initial starting point for motor ramp time and that customers examine the actual inrush and ratings of their drive system. Inrush current seen at the drive from the filter that can easily be overcome by changing the motor ramp time.</b></p>

### Sequence of Operation

1. Read and follow safety precautions.
2. After installation, ensure that:
  - All filter ground terminals are connected to ground.
  - Power wiring to the utility, drive, filter, capacitor panels and motor is in accordance with the power wiring connection diagrams shown in installation instructions section.
3. Check that moisture has not condensed on the filter components. If moisture is present, do not proceed with startup until the moisture has been removed.
4. Disconnect filter output terminals from the motor.
5. Set the drive switching frequency between 4.8 kHz and 8 kHz. Refer to the drive user manual.
6. Connect filter temperature safety overload switch into the control circuit so that the drive will shut down in an overload situation.
7. Confirm that drive voltage is present at the input terminals (U1, V1, W1) of the filter.
8. Confirm that drive voltage is present at the output terminals (U2, V2, W2) of the filter.
9. Connect the filter output to the motor.
10. Refer to the drive user manual for the drive startup procedure. Observe all safety instructions in the drive user manual.

## 5. TROUBLESHOOTING

 <b>WARNING</b>	<b>INJURY OR DEATH MAY RESULT IF THE DRIVE SAFETY PRECAUTIONS ARE NOT OBSERVED.</b>
	<p>When properly installed, this equipment has been designed to provide maximum safety for operating personnel. However, hazardous voltages and elevated temperatures exist within the confines of the enclosure. Servicing should therefore be performed by qualified personnel only and in accordance with OSHA Regulations.</p>
	<p>High voltage is used in the operation of this filter. Use Extreme caution to avoid contact with high voltage when operating, installing or repairing this filter. <b>INJURY OR DEATH MAY RESULT IF SAFETY PRECAUTIONS ARE NOT OBSERVED.</b></p>
 <b>Caution</b>	<p>After removing power, allow at least five minutes to elapse and verify that the capacitors have discharged to a safe level before contacting internal components. Connect a DC voltmeter across the capacitor terminals or terminals U1, V1 or V1, W1 and ensure that the voltage is at a safe level.</p>

To aid in troubleshooting, two interconnection diagrams and a troubleshooting guide that lists potential problems and solutions are included:

Figure 3-2: Open Panel Interconnection (p10)

Figure 3-3: Isolation Transformer (p11)

Table 5-2: Troubleshooting Guide (p16)

For specific product performance specifications, reference Table 5-1 below:

**Table 5-1: Performance Specifications**

Service Load Condition	Conventional 3 phase motors operating in volts per Hertz mode Standard step-up transformer or design for use of filter in sensor less vector mode
Input Voltage	380V - 480V +/- 10%
Harmonic Voltage Distortion	5% maximum @ 5kHz; 8% maximum @ 6-8kHz
Inverter Operating Frequency	6Hz to 300Hz
Maximum Ambient Temperature	-40C to +60C Modular Filter -40C to +90C Storage
Insulation System	Class N (200° C)
Insertion Loss (Voltage)	6% maximum @ 150Hz; 12% maximum @ 300Hz
Efficiency	>99%
Altitude without derating	3,300 feet above sea level
Maximum Motor Lead Length	15,000 feet
Relative Humidity	0% to 95% non-condensing
Current Rating	100% RMS Continuous; 150% for 1 minute Intermittent

Table 5-2: Troubleshooting Guide

<b>PROBLEM: Drive Overcurrent Fault</b>	
<b>Possible cause:</b>	Motor ramp-up time too short.
<b>Solution:</b>	MTE suggests a ramp time of >5-10 seconds. Consult drive manufacturers manual to configure proper parameters.
<b>Possible cause:</b>	Failed or incorrect wiring
<b>Solution:</b>	Verify all field and product wiring is correct.
<b>Possible cause:</b>	Parameter compatibility.
<b>Solution:</b>	Consult drive manufacturers manual for operating drive with a motor protection filter.
<b>Possible cause:</b>	Filter, Drive, Motor current ratings compatible.
<b>Solution:</b>	Verify the filter and motor are properly sized for the application.
<b>Possible cause:</b>	Drive not configured for Volts/ Hertz
<b>Solution:</b>	Vector control might be required for PM Motors in some applications. Consult drive manufacturers manual to configure proper parameters.
<b>Possible cause:</b>	Motor winding fault.
<b>Solution:</b>	Verify motor windings and hi-pot is necessary.
<b>Possible cause:</b>	Cable failure.
<b>Solution:</b>	Verify cable continuity and insulation.
<b>PROBLEM: Excessive Filter Noise</b>	
<b>Possible cause:</b>	Mismatched motor rating.
<b>Solution:</b>	Verify the filter is properly sized for the application.
<b>Possible cause:</b>	Capacitors disconnected or improperly wired.
<b>Solution:</b>	Verify the proper connection of the capacitors.
<b>Possible cause:</b>	Carrier frequency less than 4.8 kHz.
<b>Solution:</b>	Verify the carrier frequency is at least 4.8 kHz.
<b>PROBLEM: Temperature Switch Open</b>	
<b>Possible cause:</b>	Mismatched motor rating.
<b>Solution:</b>	Verify the filter is properly sized for the application.
<b>Possible cause:</b>	Capacitors disconnected or improperly wired.
<b>Solution:</b>	Verify the proper connection of the capacitors.
<b>Possible cause:</b>	Carrier frequency less than 4.8 kHz.
<b>Solution:</b>	Verify the carrier frequency is at least 4.8 kHz.
<b>Possible cause:</b>	Excessive ambient temperature.
<b>Solution:</b>	Ensure filter is operating within specified ambient temperature below 60° C.
<b>PROBLEM: Motor will not turn.</b>	
<b>Possible cause:</b>	No power.
<b>Solution:</b>	Check fuses or breakers for proper input power.
<b>Possible cause:</b>	Motor incorrectly wired.
<b>Solution:</b>	Check for wiring faults.
<b>Possible cause:</b>	Locked rotor motor load.
<b>Solution:</b>	Check motor load.
<b>Possible cause:</b>	Drive fault.
<b>Solution:</b>	Consult drive manufacturers manual.
<b>Possible cause:</b>	Capacitors disconnected or improperly wired.
<b>Solution:</b>	Verify the proper connection of the capacitors.
<b>Possible cause:</b>	Overloaded motor.
<b>Solution:</b>	Verify the motor is properly sized for the application.