

Matrix® APAX

380V – 415V 50Hz INSTALLATION GUIDE

FORM: MX-IG-E
REL. January 2018
REV. 002
© 2018 MTE Corporation

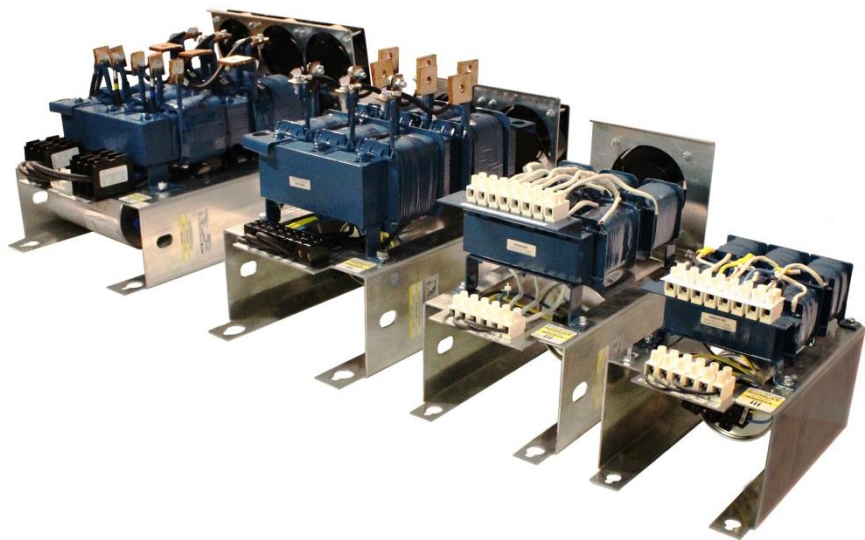

WARNING

High Voltage! Only a qualified electrician can carry out the electrical installation of this filter.

Quick Reference

1	How to Install	Pages 7 – 12
2	Startup/Troubleshooting	Pages 13 – 16

This page intentionally left blank

TABLE OF CONTENTS

1. WARNINGS	4
WARNINGS AND CAUTIONS.....	4
PRODUCT SAFETY LABELING.....	4
GENERAL SAFETY INSTRUCTIONS.....	5
2. INTRODUCTION	6
RECEIPT & REPAIR STATEMENT	6
WARRANTY.....	6
3. HOW TO INSTALL	7
INSTALLATION CHECKLIST	7
GROUNDING	8
POWER WIRING CONNECTION	9
BASIC SCHEMATIC DIAGRAMS	10
INTERCONNECTION DIAGRAM	11
CONTACTOR WIRING OPTION.....	12
4. START UP	13
STARTUP CHECKLIST	13
5. TROUBLESHOOTING	14
HARMONIC FILTER FIELD CHECKS	15

List of Figures

Figure 3-1: Basic Schematic Diagram	10
Figure 3-2: Matrix APAX Panel Mounted Interconnection	11
Figure 3-3: Contactor Wiring Block (44A model shown)	12



List of Tables

Table 3-1: Over Temperature Switch.....	8
Table 5-1: Performance Specifications	14
Table 5-2: Troubleshooting Guide	16



1. WARNINGS

Warnings and Cautions

There are two types of warnings in this manual:



 WARNING	WARNING describes situations that can lead to serious faults, physical injuries, or even death.
 Caution	Caution describes situations that can lead to malfunction or possible equipment damage.

The following symbols are used in this manual:



 WARNING	High Voltage Warning: warns of situations that dangerously high voltage is involved. Failure to use proper precautions may lead to serious injury or even death.
 WARNING	General Warning: warns of situations that can result in serious injury or death if proper precautions are not used.
 Caution	General Caution: identifies situations that could lead to malfunction or possible equipment damage.

Product Safety Labeling

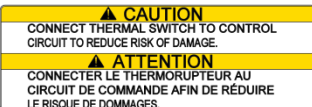
The following labels are placed on the Matrix APAX product:

	Label notes to install to refer to instruction manual first before installing.
	High Voltage: surfaces on product can have high voltage which can cause injury.
	Wait five minutes for capacitors to discharge. Verify safe voltage level before servicing.
	Connect Thermal Switch: connecting the thermal switch can reduce risk of damage.

General Safety Instructions

 WARNING	<p>High Voltage! Only a qualified electrician can carry out the electrical installation of this filter.</p>
	<p>High voltage is used in the operation of this filter. Use Extreme caution to avoid contact with high voltage when operating, installing or repairing this filter. Injury or death may result if safety precautions are not observed.</p>
 WARNING	<p>The opening of the branch circuit protective device may be an indication that a fault current has been interrupted. To reduce the risk of fire or electrical shock, current-carrying parts and other components of the filter should be examined and replaced if damaged.</p>
	<p>An upstream disconnect/protection device must be used as required by the National Electrical Code (NEC) or governing authority.</p>
	<p>Even if the upstream disconnect/protection device is open, the drive down stream of the filter may feedback high voltage to the filter. The drive safety instructions must be followed. Injury or death may result if safety precautions are not observed.</p>
	<p>The filter must be grounded with a grounding conductor connected to all grounding terminals.</p>
	<p>Only spare parts obtained from MTE Corporation or an authorized MTE distributor can be used.</p>
	<p>After removing power, allow at least five minutes to elapse and verify that the capacitors have discharged to a safe level before contacting internal components. Connect a DC voltmeter across the capacitor terminals and ensure that the voltage is at a safe level.</p>
 Caution	<p>Loose or improperly secured connections may damage or degrade filter performance. Visually inspect and secure all electrical connections before power is applied to the filter.</p>
	<p>Product should not be mounted on wood or any other combustible surface. Doing so could lead to fire or damage to the product.</p>
	<p>The user of this filter must assure that the input voltage and frequency is correct for the filter rating and that the voltage applied falls within the rated operating tolerance envelop specified for the filter. For sever power line applications where the power feed is likely to experience surges and transients that exceed the input voltage rating, it is recommended that a TVSS (Transient Voltage Surge Suppression) or SPD (Surge Protection Device) be deployed ahead of the filter to reduce the possibility of exceeding the filter rated voltage. Consult with TVSS or SPD manufacturer to determine the correct protection for your power line conditions.</p>
	<p>Filter must be mounted in the proper orientation per labeling.</p>
	<p>Fans must be operating properly before powering up the filter.</p>

2. INTRODUCTION

The purpose of this manual is to aid in the proper installation of the Matrix® APAX.

For most current product information, including technical reference manual, please refer to website:

<http://www.mtecorp.com/products/matrix-apax-harmonic-filters/>

This manual is intended for use by personnel experienced in the operation and maintenance of drives. Because of the high voltages required by the filter, drive and the potential dangers presented by rotating machinery, it is essential that all personnel involved in the operation and maintenance of this filter know and practice the necessary safety precautions for this type of equipment. Personnel should read and understand the instructions contained in this manual before installing, operating or servicing the filter and drive to which it is connected.

Receipt & Repair Statement

Upon Receipt of this Filter:

The Matrix APAX Harmonic Filter has been subjected to demanding factory tests before shipment. Carefully inspect the shipping container for damage that may have occurred in transit. Then unpack the filter and carefully inspect for any signs of damage. Save the shipping container for future transport of the filter.

In the event of damage, please contact and file a claim with the freight carrier involved immediately.

If the equipment is not going to be put into service upon receipt, cover and store the filter in a clean, dry location. After storage, ensure that the equipment is dry and that no condensation or dirt has accumulated on the internal components of the filter before applying power.

Repair/Exchange Procedure

MTE Corporation requires a Return Material Authorization Number and form before we can accept any filters that qualify for return or repair. If problems or questions arise during installation, setup, or operation of the filter, please contact MTE for assistance at:

Toll Free: 1-800-455-4MTE (1-800-455-4683)

International Tel: +1-262-253-8200



Fax: +1-262-253-8222

Warranty

One year from the date of shipment. See www.mtecorp.com for details.

3. HOW TO INSTALL

Installation Checklist

 WARNING	<p>Prior to installation, please refer to all general warnings on page 4. Failure to practice this can result in bodily injury!</p>
	<p>Input and output wiring to the filter should be performed by authorized personnel in accordance with NEC and all local electrical codes and regulations.</p>
 WARNING	<p>The filter is designed for use with copper conductors with a minimum temperature rating of 75 degrees C.</p>

Matrix® APAX Panel Mount

Do not install in or near a corrosive environment.

Avoid locations where the filter would be subjected to excessive vibrations.

It is recommended that the panel is mounted vertically with the fan at the bottom to allow airflow upwards and away from the reactors.

The panel must be located in the lowest temperature regions of the enclosure – generally toward the bottom and away from high temperature components.

Include the power dissipation of the filter along with all the other components located in the enclosure to determine the internal temperature rise and cooling requirements of the enclosure.

Allow a minimum of six inches (6”) around the fan to allow for proper ventilation.

Refer to Article 430 Table 430.91 of the National Electrical code for the selection of the appropriate enclosure Type Number for your application.

Grounding



WARNING

The filter must always be grounded with a grounding conductor connected to ground terminals.

Cable Shield Grounding

For cable shield grounding follow the drive manufactures recommendations.

Grounding and Ground Fault Protection

The filter must always be grounded with a grounding conductor connected to all ground terminals.

Due to high leakage currents associated with variable frequency drives, ground fault protective devices do not necessarily operate correctly when placed ahead of a Matrix Filter feeding a drive. When using this type of device, its function should be tested in the actual installation.

Over Temperature Interlock

An over temperature interlock circuit should be used in conjunction with thermal switch to turn off the drive to prevent filter damage due to abnormal operating conditions. The temperature switch is normally closed and will open when an internal reactor temperature of 180°C is reached. See Table 3-1 below for contact rating information and the drive user manual for interconnection information.

Table 3-1: Over Temperature Switch

<i>NC Switch</i> opens at 180 Deg. +/- 5 Deg. C		
Current Amps	Voltage	Contact Load
6	120 AC	Resistive Loads
3	120 AC	Inductive Loads
3	240 AC	Resistive Loads
2.5	240 AC	Inductive Loads
8	12 VDC	Resistive Loads
4	24 VDC	Resistive Loads

MTE strongly recommends the use of the over temperature switch to prevent damage to the filter in rare instances of overheating from abnormal operating conditions.

Power Wiring Connection

 WARNING	Input and output power wiring to the filter should be performed by authorized personnel in accordance with the NEC and all local electrical codes and regulations. Cable lugs and mounting hardware are provided by the customer.
	Any extremely low or high resistance readings indicate miswiring and may result in damage to filter components if not corrected.

Verify that the power source to which the filter is to be connected is in agreement with the nameplate data on the filter. A fused disconnect switch or circuit breaker should be installed between the filter and its source of power in accordance with the requirements of the NEC and all local electrical codes and regulations. Refer to the drive user manual for selection of the correct fuse rating and class.

Refer to the drive user manual for instructions on interconnecting the drive and motor and the correct start-up procedures for the drive.

The filter is designed for use with copper conductors with a minimum temperature rating of 75 degrees C.

Wiring Checks

Using Figure 3-1 (p10), visually check the wired components to confirm, verify, and correct wiring. Then, with a multi meter, check phase to phase isolation using the 100 K ohm range. The multi meter will read the parallel equivalent of the bleeder resistors after the capacitors initially charge. All phase to phase resistance values should be the same.

Check for the Following Faults:

- Capacitor shorted
- Capacitor bus not connected
- Capacitor bus to chassis short
- Paralleling wiring errors

Basic Schematic Diagrams

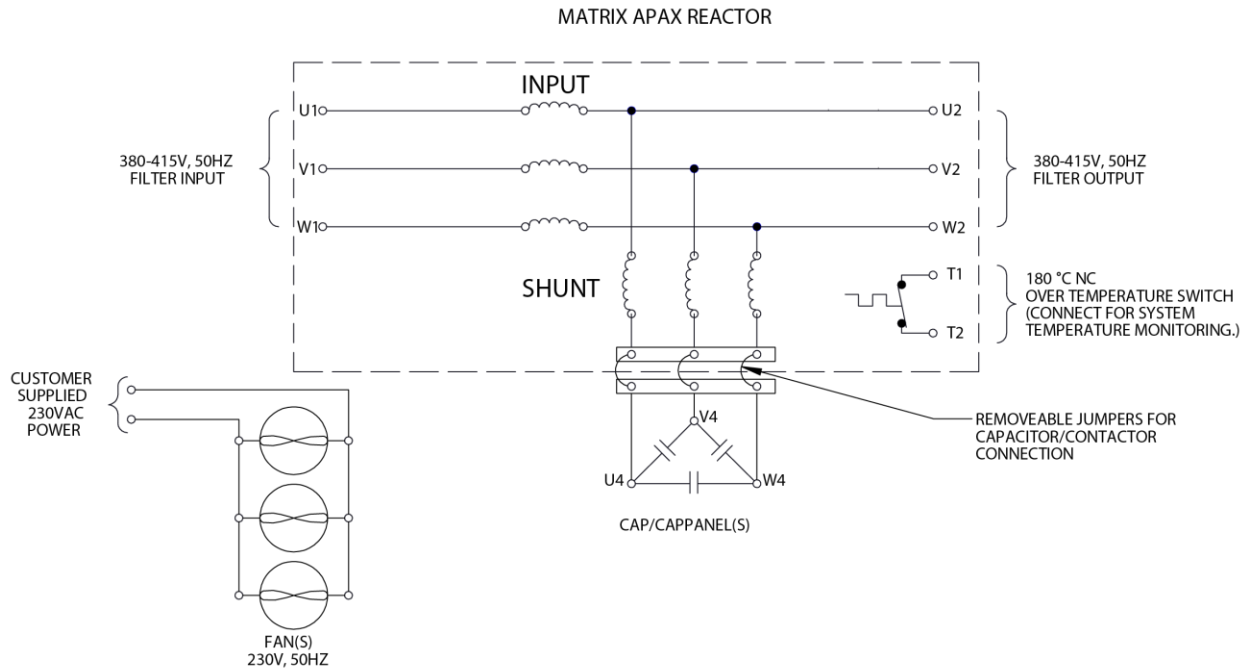

NOTES:

1. FANS MUST BE CONNECTED AND OPERATING FOR PROPER OPERATION OF FILTER.
2. UNITS CONTAIN BETWEEN ZERO AND THREE FANS, DEPENDING ON FILTER SIZE.

Figure 3-1: Basic Schematic Diagram

Interconnection Diagram

MATRIX-APAX OPEN PANEL UNIT INTERCONNECTION DIAGRAM

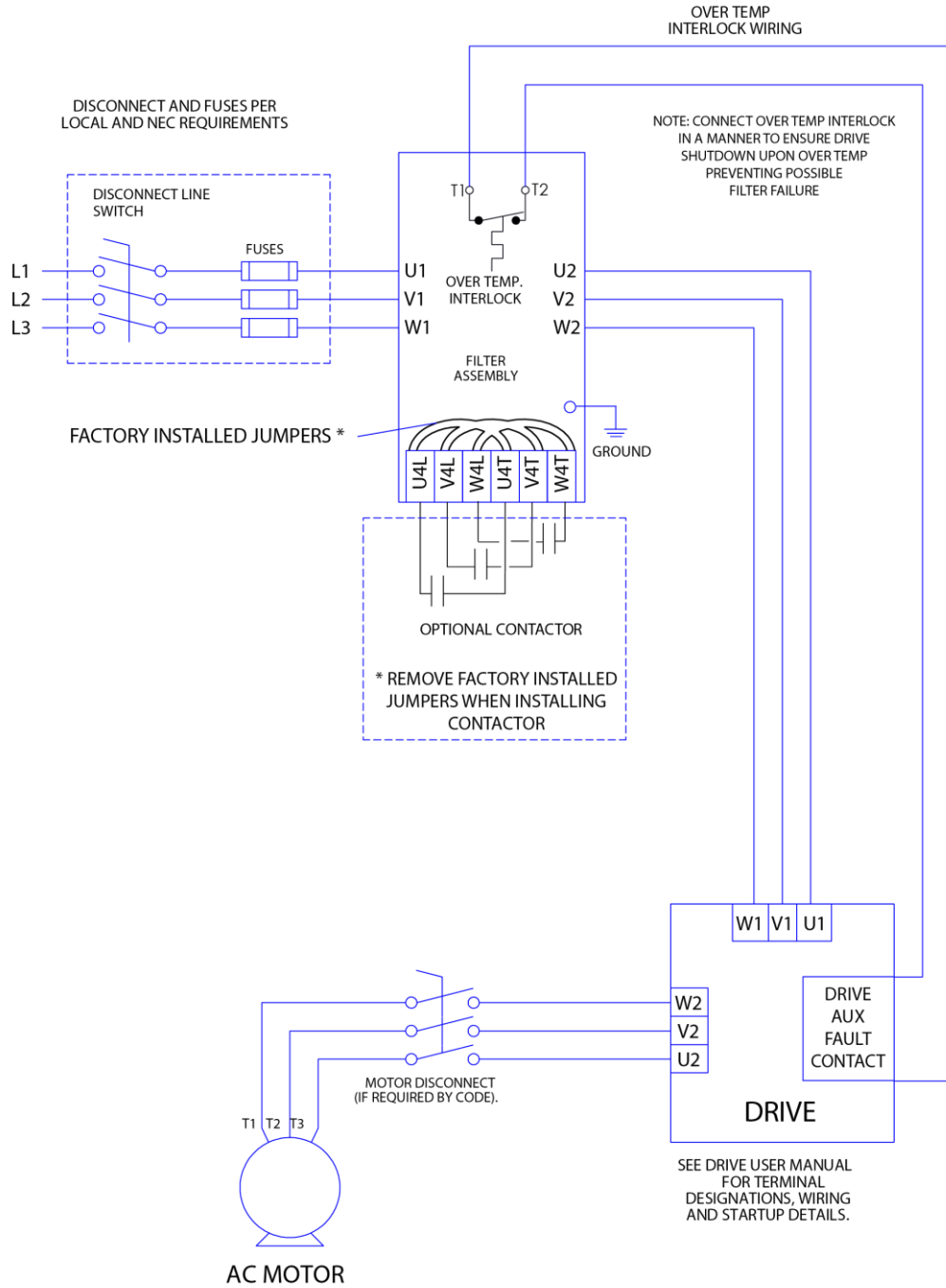

Figure 3-2: Matrix APAX Panel Mounted Interconnection

Contactor Wiring Option

The Matrix® APAX comes with a user configurable contactor wiring block. This option allows the user to add disconnect options to meet their applications. Figure 3-3 (p12) shows a representation of the contactor wiring block (the terminal block varies depending on model size). Refer to Figure 3-2 (p11) for the wiring diagram. The units will be shipped with factory installed jumpers as shown in the figure. Jumpers must be removed for installation of contactor option.

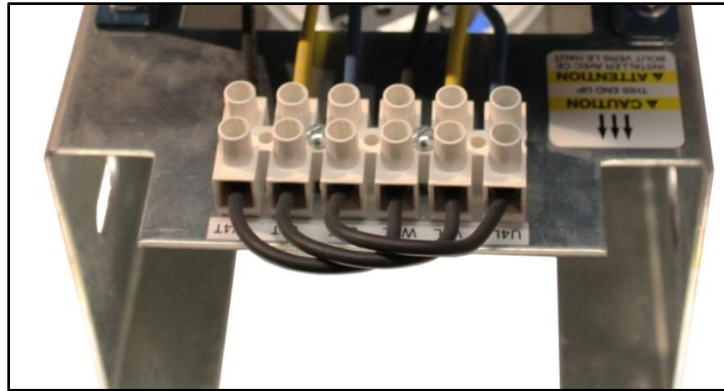



Figure 3-3: Contactor Wiring Block (44A model shown)

4. START UP

Startup Checklist

Safety Precautions

Before startup, observe the following warnings and instructions:

 WARNING	<p>Internal components of the filter are at line potential when the filter is connected to the drive. This voltage is extremely dangerous and may cause death or severe injury if you come in contact with it.</p>
	<p>Use extreme caution to avoid contact with line voltage when checking for power. INJURY OR DEATH MAY RESULT IF SAFETY PRECAUTIONS ARE NOT OBSERVED.</p>
	<p>Damage to equipment may occur if the drive startup procedures are not observed.</p>

Sequence of Operation

1. Read and follow safety precautions.
2. After installation, ensure that:
 - All filter ground terminals are connected to ground.
 - Power wiring to the utility, drive and motor is in accordance with the power wiring connection diagrams shown in installation instructions section.
3. Check that moisture has not condensed on the filter components. If moisture is present, do not proceed with startup until the moisture has been removed.
4. Disconnect the filter output from the drive.
5. Connect the filter to the utility.
6. Confirm that line voltage is present at the input terminals (U1, V1, W1) of the filter.
7. Confirm that line voltage is present at the output terminals (U2, V2, W2) of the filter and that it is less than or equal to 1.05 times the input voltage.
8. Using a clamp on Amp meter, check input phase currents to verify they are within a 5% match to each other and approximately 30% of filter current rating.
9. Remove power and verify that **NO VOLTAGE** is present on the filter terminals.
10. Connect the filter output to the drive.
11. Refer to the drive user manual for the drive startup procedure. Observe all safety instructions in the drive user manual.

5. TROUBLESHOOTING

 WARNING	INJURY OR DEATH MAY RESULT IF THE DRIVE SAFETY PRECAUTIONS ARE NOT OBSERVED.
	<p>When properly installed, this equipment has been designed to provide maximum safety for operating personnel. However, hazardous voltages and elevated temperatures exist within the confines of the enclosure. Servicing should therefore be performed by qualified personnel only and in accordance with OSHA Regulations.</p>
	<p>High voltage is used in the operation of this filter. Use Extreme caution to avoid contact with high voltage when operating, installing or repairing this filter. INJURY OR DEATH MAY RESULT IF SAFETY PRECAUTIONS ARE NOT OBSERVED.</p>

To aid in troubleshooting, an interconnection diagram and a troubleshooting guide that lists potential problems and solutions are included:

Figure 3-2: Matrix APAX Panel Mounted Interconnection (p11)

Table 5-2: Troubleshooting Guide (p16)

For specific product performance specifications, reference Table 5-1 below:

Table 5-1: Performance Specifications

Service Load Condition	Load: 6-pulse rectifier only
Input Voltage	380V - 415V +/- 10%; 50 + 0.75Hz; 3-phase
Maximum THID	With DC Link: 12% Max @ 40% Load; 8% Max @ Full Load Without DC Link: 17% @ 40% Load; 12% @ Full Load
Maximum Ambient Temperature	-40C to +50C Open Panel Filters -40C to +90C Storage
Insertion Loss @ Full Load	<5%
Efficiency	>98%
Altitude without derating	3,300 feet above sea level
Relative Humidity	0% to 95% non-condensing
Current Rating	150% for 1 minute duration with 10% output voltage reduction of nominal of voltage
Fan Life Expectancy	80,000 hours @ 40C

Harmonic Filter Field Checks

1. Read and understand the Matrix APAX Technical Reference Manual which can be downloaded at www.mtecorp.com/matrix-apax-literature-documents/. Locate figures and drawings for your particular filter and identify the terminal locations.
2. Disconnect all power and remove input power wiring from U1, V1, and W1 terminals.
3. Remove VFD drive power connections from filter terminals U2, V2, and W2 as well as any control wiring to the filter contactor or temperature switch. (For filters using control transformers: remove power fuses on top of transformer.)
4. Visually inspect filter terminals and wiring lugs for signs of heat and corrosion. **Contact factory if any wires appear to be missing or cut!**
5. Inspect the U4, V4, and W4 capacitor interconnect terminals and wiring.
6. Visually inspect all capacitors for signs of case deformation, bowing of the top, leaking oil or terminal damage. Note the CAP- # and date code of any damaged capacitors.
7. Using a multi meter set to read 100K ohms check:
 - a. Phase to phase U1-V1-W1-U1 (mechanically activate contactor if present) after reactor and caps charge reading should be about 40K (total equivalent breeder resistance value). Open circuit or very low readings indicate a problem.
 - b. Phase to chassis U1- case, V1-case, and W1-case; low readings indicate a ground fault problem.
8. Ensure the “disconnect” is safe then wire the utility power to U1, V1, and W1.
9. Apply power and verify that proper output voltage is present on U2, V2, and W2.
10. Using a clamp on amp meter read the filter input current:
 - a. Readings will be 0.4 of the capacitor current listed in the Matrix APAX Technical Reference Manual found at www.mtecorp.com/matrix-apax-literature-documents/. Mechanically activate the contactor if the filter is equipped with one. Readings should be the same (+/- 5%) for all phase currents; **contact the factory if currents are out of tolerance!**
 - b. Open contactor readings will show zero current for all phases.
11. Disconnect filter power and wire the VFD to U2, V2, and W2 as well as any control wiring to the filter contactor or temperature switch. Replace any control transformer fuses. Follow the drive power startup guidelines in the drive manufacturer’s user manual.

Table 5-2: Troubleshooting Guide

PROBLEM: Line voltage is not present at the filter output terminals.	
Possible cause:	Power to the filter is turned off.
Solution:	Turn power on.
Possible cause:	One or more external line fuses are blown.
Solution:	Verify the continuity of line fuses in all phases. Replace as necessary.
PROBLEM: Full Load Harmonic current distortion exceeds 12% at full load.	
Possible cause:	A capacitor has failed.
Solution:	Inspect the tops of all capacitors for bowing. Replace failed capacitors.
Possible cause:	Source impedance is less than 1.5%.
Solution:	Add a minimum 1.5% impedance line reactor to the filter input.
Possible cause:	Input source voltage harmonic distortion.
Solution:	Identify equipment causing harmonic voltage distortion and add filters as required or accept elevated THVD.
PROBLEM: Filter output voltage is not within specification	
Possible cause:	Filter input voltage is not within specification.
Solution:	Check the AC input line voltage and verify that it is within tolerance. Refer to the filter service conditions and performance specifications for tolerances.
Possible cause:	Source impedance is out of tolerance.
Solution:	Verify that the source impedance is within tolerance. Refer to the filter service conditions and performance specifications for tolerances.
Possible cause:	One or more Capacitors are damaged.
Solution:	Visually check capacitor top for distortion or doming. Check for shorts or open caps. Replace failed capacitors.
Possible cause:	Drive set up parameter does not allow for input filter
Solution:	Consult drive manufacturer to update setup to accommodate input filter.
Possible cause:	Input voltage subject to extreme transients such as switching between two voltage sources. Drive faults on over or under voltage.
Solution:	Source switching is not recommended without proper phase synchronizing or allowing reasonable time delay before transfer to new source.