

dV Sentry™

208V – 600V

INSTALLATION GUIDE

FORM: DVS-IG-E
REL. January 2018
REV. 003
© 2018 MTE Corporation

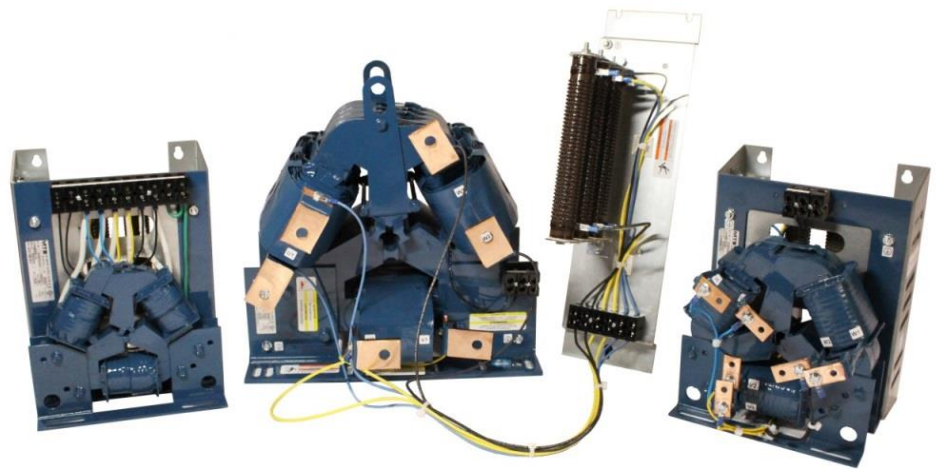

WARNING

High Voltage! Only a qualified electrician can carry out the electrical installation of this filter.

Quick Reference

1	How to Install	Pages 6 – 14
2	Startup/Troubleshooting	Pages 14 – 16

TABLE OF CONTENTS

1. WARNINGS	3
WARNINGS AND CAUTIONS	3
PRODUCT SAFETY LABELING	3
GENERAL SAFETY INSTRUCTIONS	4
2. INTRODUCTION.....	5
WWW.MTECORP.COM/DV-SENTRY/	5
RECEIPT & REPAIR STATEMENT.....	5
WARRANTY	5
3. HOW TO INSTALL	6
INSTALLATION CHECKLIST	6
GROUNDING	7
POWER WIRING CONNECTION	9
BASIC SCHEMATIC DIAGRAMS.....	10
INTERCONNECTION DIAGRAM – PANEL (3A-110A) AND ENCLOSED (3A-600A)	11
INTERCONNECTION DIAGRAM – MODULAR (130A-600A)	12
TORQUE RATINGS.....	13
4. START UP	14
STARTUP CHECKLIST	14
5. TROUBLESHOOTING.....	15

List of Figures

Figure 3-1: Basic Schematic Diagram	10
Figure 3-2: Panel Mounted and Enclosed Diagram	11
Figure 3-3: Open Panel Diagram.....	12



List of Tables

Table 3-1: Over Temperature Switch	8
Table 3-2: Torque Ratings	13
Table 5-1: Performance Specifications.....	15
Table 5-2: Troubleshooting Guide.....	16



1. WARNINGS

Warnings and Cautions

There are two types of warnings in this manual:



 WARNING	<p>WARNING describes situations that can lead to serious faults, physical injuries, or even death.</p>
 Caution	<p>Caution describes situations that can lead to malfunction or possible equipment damage.</p>

The following symbols are used in this manual:



 WARNING	<p>High Voltage Warning: warns of situations that dangerously high voltage is involved. Failure to use proper precautions may lead to serious injury or even death.</p>
 WARNING	<p>General Warning: warns of situations that can result in serious injury or death if proper precautions are not used.</p>
 Caution	<p>General Caution: identifies situations that could lead to malfunction or possible equipment damage.</p>

Product Safety Labeling

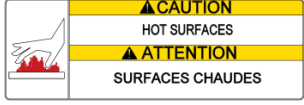
The following labels are placed on the dV Sentry product:

	<p>Label notes to install to refer to instruction manual first before installing.</p>
	<p>High Voltage: surfaces on product can have high voltage which can cause injury.</p>
	<p>Connect Thermal Switch: connecting the thermal switch can reduce risk of damage.</p>
	<p>Hot Surfaces: surfaces of product can be hot at times and cause burns.</p>

General Safety Instructions

 WARNING	<p>High Voltage! Only a qualified electrician can carry out the electrical installation of this filter.</p>
	<p>High voltage is used in the operation of this filter. Use extreme caution to avoid contact with high voltage when operating, installing or repairing this filter. Injury or death may result if safety precautions are not observed.</p>
 WARNING	<p>The opening of the branch circuit protective device may be an indication that a fault current has been interrupted. To reduce the risk of fire or electrical shock, current-carrying parts and other components of the filter should be examined and replaced if damaged.</p>
	<p>An upstream disconnect/protection device must be used as required by the National Electrical Code (NEC) or governing authority.</p>
	<p>Even if the upstream disconnect/protection device is open, the drive downstream of the filter may feedback high voltage to the filter. The drive safety instructions must be followed. Injury or death may result if safety precautions are not observed.</p>
	<p>The filter must be grounded with a grounding conductor connected to all grounding terminals. Modular filters must have reactor grounded through a 2"x2" area cleaned of paint and varnish on lower mounting bracket.</p>
	<p>Only spare parts obtained from MTE Corporation or an authorized MTE distributor can be used.</p>
 Caution	<p>Loose or improperly secured connections may damage or degrade filter performance. Visually inspect and secure all electrical connections before power is applied to the filter.</p>
	<p>Wiring should not be routed underneath panel in resistor housing. Doing so could result in fire or damage to the product.</p>
	<p>Product should not be mounted on wood or any other combustible surface. Doing so could lead to fire or damage to the product.</p>

3. INTRODUCTION

The purpose of the manual is to aid in the proper installation of the dV Sentry.

For most current product information, including technical reference manual, please refer to website:

www.mtecorp.com/dv-sentry/

This manual is intended for use by personnel experienced in the operation and maintenance of drives. Because of the high voltages required by the filter, drive and the potential dangers presented by rotating machinery, it is essential that all personnel involved in the operation and maintenance of this filter know and practice the necessary safety precautions for this type of equipment. Personnel should read and understand the instructions contained in this manual before installing, operating or servicing the filter and drive to which it is connected.

Receipt & Repair Statement

Upon Receipt of this Filter:

The dV Sentry Motor Protection Filter has been subjected to demanding factory tests before shipment. Carefully inspect the shipping container for damage that may have occurred in transit. Then unpack the filter and carefully inspect for any signs of damage. Save the shipping container for future transport of the filter.

In the event of damage, please contact and file a claim with the freight carrier involved immediately.

If the equipment is not going to be put into service upon receipt, cover and store the filter in a clean, dry location. After storage, ensure that the equipment is dry and that no condensation or dirt has accumulated on the internal components of the filter before applying power.

Repair/Exchange Procedure

MTE Corporation requires a Return Material Authorization Number and form before we can accept any filters that qualify for return or repair. If problems or questions arise during installation, setup, or operation of the filter, please contact MTE for assistance at:

Toll Free: 1-800-455-4MTE (1-800-455-4683)

International Tel: +1- 262-253-8200



Fax: +1-262-253-8222

Warranty

Three years from the date of shipment. See www.mtecorp.com for details.

4. HOW TO INSTALL

Installation Checklist

 WARNING	<p>Prior to installation, please refer to all general warnings on page 3. Failure to practice this can result in bodily injury!</p>
	<p>Input and output wiring to the filter should be performed by authorized personnel in accordance with NEC and all local electrical codes and regulations.</p>
 WARNING	<p>The filter is designed for use with copper conductors with a minimum temperature rating of 75 degrees C.</p>

dV Sentry Filters are supplied in the following mechanical configurations:

- Panel assemblies (3A-110A): Reactor and resistor are assembled on a panel and pre-wired together.
- Modular assemblies (130A-600A): Resistors are pre-wired to a terminal block on a panel and shipped with a modular reactor.
- Floor mounted general purpose NEMA 1/2 & 3R cabinets (3A - 600A): Reactor and resistor/resistor panel are supplied in a cabinet with all items pre-wired together.

NOTE: 3A – 110A panel mounted assemblies are designed for mounting horizontally (base) or vertically (back panel) in the customer’s enclosure. Vertically mounted filters must have terminal block on top.

130A – 600A panel mounted assemblies are designed for horizontal (base) mounting only.

Include the power dissipation of the filter along with all the other components located in the enclosure to determine the internal temperature rise and cooling requirements of the enclosure.

Select a well-ventilated area suitable for the NEMA enclosure type number. Do not install in or near a corrosive environment. Avoid locations where the filter would be subjected to excessive vibrations.

Refer to Article 430 Table 430.91 of the National Electrical code for the selection of the appropriate enclosure Type Number for your application.

Grounding

 WARNING	<p>The filter must always be grounded with a grounding conductor connected to ground terminals.</p>
	<p>For panel mounted units, ensure a 2” x 2” area is cleaned of paint and varnish on lower mounting bracket for ground connection.</p>

NOTE: For cable shield grounding follow the drive manufacturer’s recommendations.

Location & Spacing

Panel mounted (open-panel) filters are designed for mounting in the customer’s enclosure. Include the power dissipation of the filter along with all the other components located in the panel to determine the internal temperature rise and cooling requirements of the enclosure. A general guideline is to allow a side clearance of four (4) inches and a vertical clearance of six (6) inches for proper heat dissipation and access within the enclosure. Clearances may be less if proper ventilation exists. Filter components must operate within temperatures specified in this manual or filter operating life will be compromised. Also be aware of minimum electrical clearances as defined by the appropriate system safety standard(s). Panel mounted dV Sentry Filters generate heat and should be positioned away from heat sensitive components. Ensure that proper panel orientation is maintained. Avoid locations where the filter would be subjected to excessive vibrations. Locate the filter as close to the drive as possible. For applications where the cable length exceeds fifty (50) feet between the drive and filter, contact MTE.

General purpose NEMA 1/2 and NEMA 3R enclosed filters are designed for floor mounting in an environment suitable for the enclosure type. Do not install in or near a corrosive environment. Avoid locations where the filter would be subjected to excessive vibrations. Allow a minimum side and back clearance of eight (8) inches and front clearance of thirty-six (36) inches for proper heat dissipation and access. Locate the filter as close to the drive as possible.

Over Temperature Interlock

An over temperature interlock circuit should be used in conjunction with thermal switch to turn off the drive to prevent filter damage due to abnormal operating conditions. The temperature switch is normally closed and will open when an internal reactor temperature of 150°C is reached. See Table 4-1 below for contact rating information and the drive user manual for interconnection information.

Table 4-1: Over Temperature Switch

NC Switch opens at 150 Deg. +/- 5 Deg. C		
Current Amps	Voltage	Contact Load
6	120 AC	Resistive Loads
3	120 AC	Inductive Loads
3	240 AC	Resistive Loads
2.5	240 AC	Inductive Loads
8	12 VDC	Resistive Loads
4	24 VDC	Resistive Loads

MTE highly recommends the use of the over temperature switch to prevent damage to the filter in rare instances of overheating from abnormal operating conditions

Power Wiring Connection

 WARNING	<p>Input and output power wiring to the filter should be performed by authorized personnel in accordance with the NEC and all local electrical codes and regulations.</p> <p>Cable lugs and mounting hardware are provided by the customer.</p>
	<p>Any extremely low or high resistance readings indicate miswiring and may result in damage to filter components if not corrected.</p>
	<p>On NEMA 3R enclosures, CAB-26AP and larger, no live parts shall be mounted below 8 inches from the bottom of the enclosure.</p>

Verify that the power source to which the filter is to be connected is in agreement with the nameplate data on the filter. A fused disconnect switch or circuit breaker should be installed between the filter and its source of power in accordance with the requirements of the NEC and all local electrical codes and regulations. Refer to the drive user manual for selection of the correct fuse rating and class.

For 3A – 110A panel mounted filter applications, interconnection between the filter, its power source, and the drive is shown in Figure 4-2 (p11).

For 130A – 600A open panel filter applications, interconnection between the filter, its power source, the resistor panel, and the drive is shown in Figure 4-2 (p11).

For all filters supplied in general purpose NEMA 1/2 & 3R cabinets, interconnection between the filter, its power source, and the drive is shown in Figure 4-3 (p12).

Wire gauge range and terminal torque requirements for the dV Sentry and the resistor panel are shown in Table 4-2 (p13).

Refer to the drive user manual for instructions on interconnecting the drive and motor and the correct start-up procedures for the drive.

The filter is designed for use with copper conductors with a minimum temperature rating of 75 degrees C.

Basic Schematic Diagrams

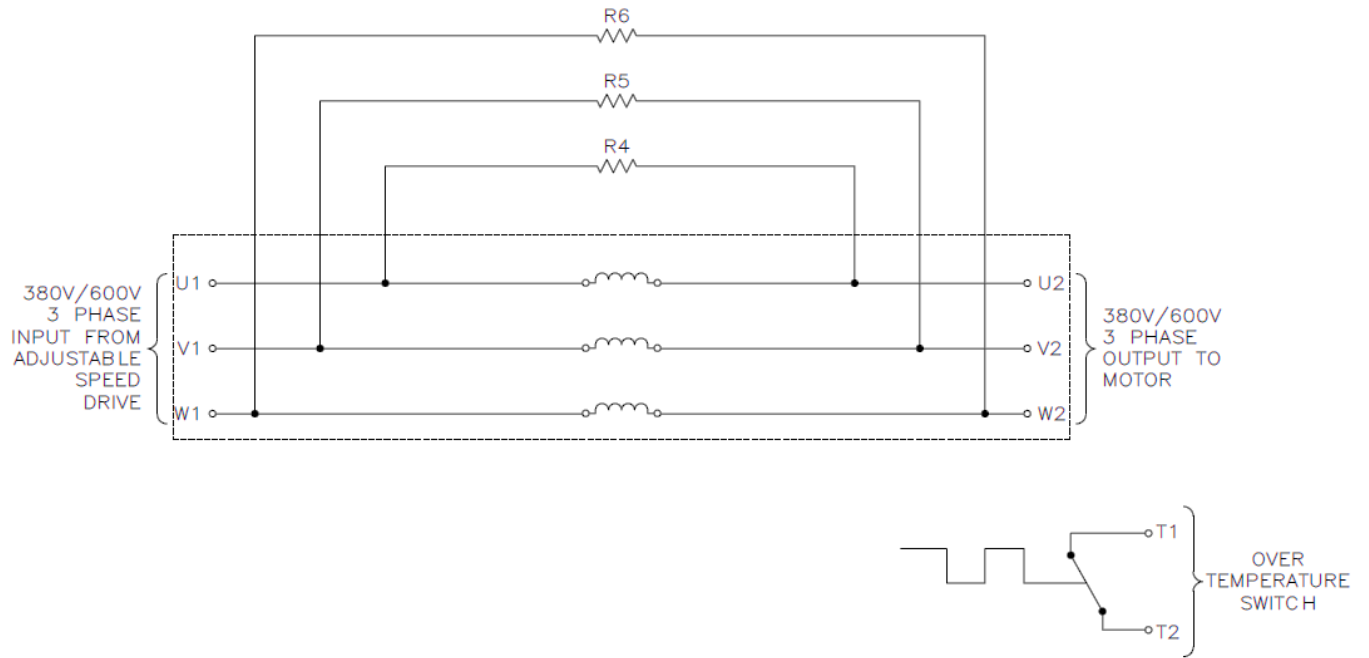

Figure 4-1: Basic Schematic Diagram

Interconnection Diagram – Panel (3A-110A) and Enclosed (3A-600A)

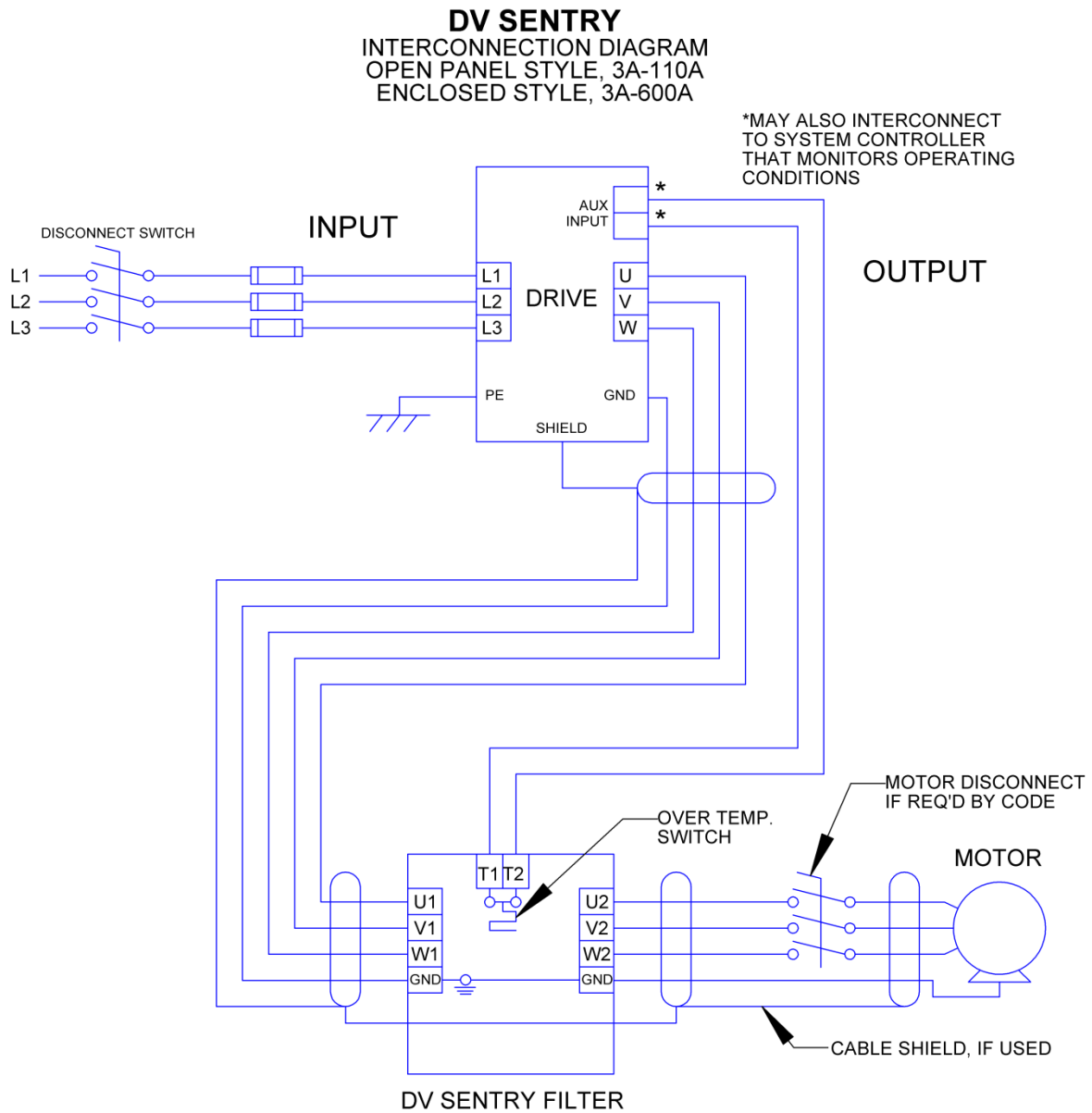

Figure 4-2: Panel Mounted and Enclosed Diagram

Interconnection Diagram – Modular (130A-600A)

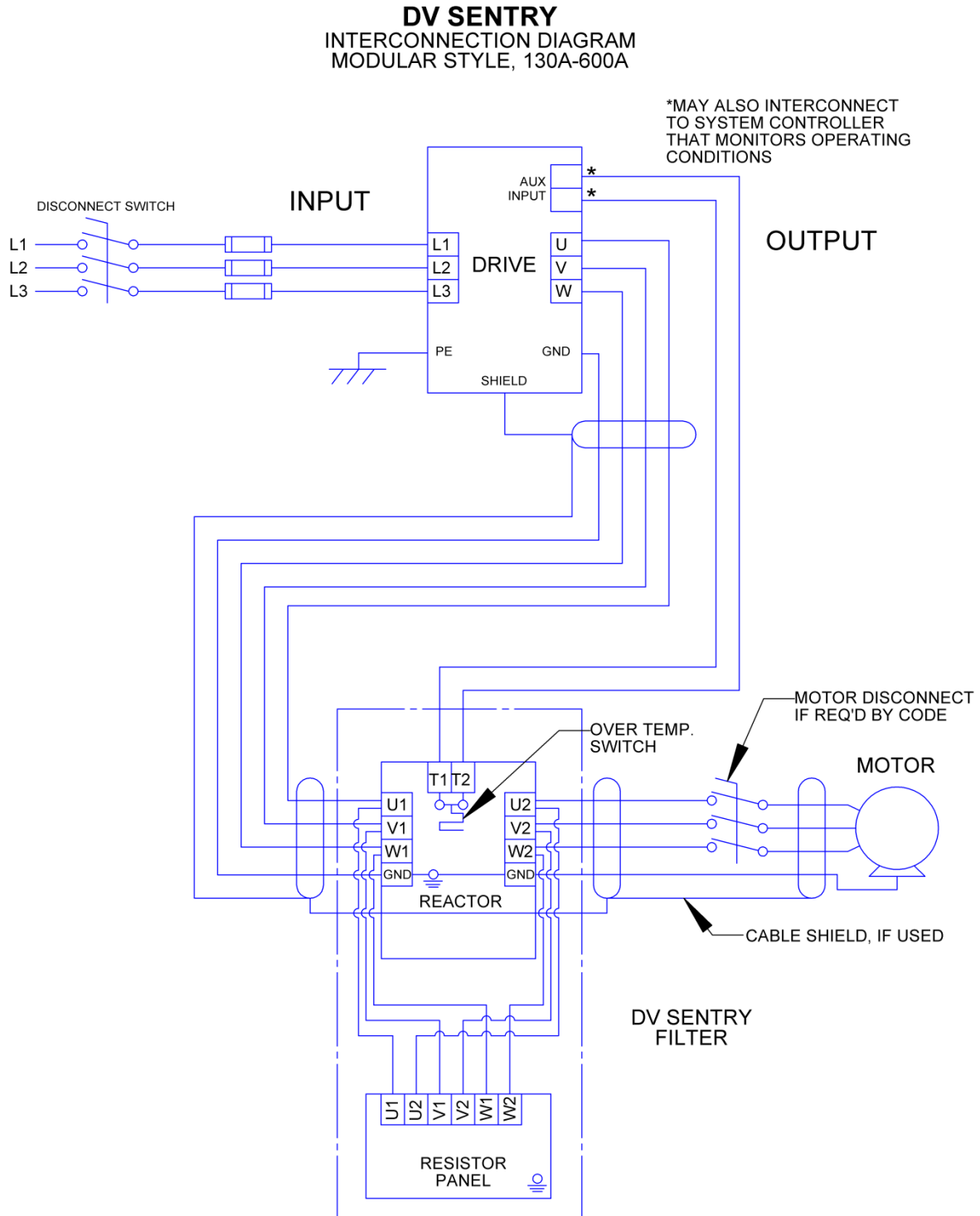

Figure 4-3: Open Panel Diagram

Torque Ratings

Table 4-2: Torque Ratings

Filter Rating (Amps)	DV SENTRY Terminals				
	Input /Output Power U1-V1-W1 / U2-V2-W2		Resistor Panel Terminals U1-V1-W1 / U2-V2-W2		
	Recommended Minimum Wire Size (AWG)	Terminal Torque (in-lbs.)	Resistor Panel Part Number	Recommended Wire Size (AWG)	Terminal Torque (in-lbs.)
3	14	16	N/A	N/A	N/A
5	14	16	N/A	N/A	N/A
7	14	16	N/A	N/A	N/A
9	14	16	N/A	N/A	N/A
12	14	16	N/A	N/A	N/A
17	12	16	N/A	N/A	N/A
22	10	16	N/A	N/A	N/A
27	10	16	N/A	N/A	N/A
35	8	16	N/A	N/A	N/A
45	8	16	N/A	N/A	N/A
55	6	16	N/A	N/A	N/A
65	6	N/A	N/A	N/A	N/A
80	4	N/A	N/A	N/A	N/A
110	2	N/A	N/A	N/A	N/A
130	1	N/A	RESPANEL-012	14	16
160	4(2x) or 2/0	N/A	RESPANEL-012	14	16
200	3(2x) or 3/0	N/A	RESPANEL-012	14	16
250	1 (2x) or 250kcmil	N/A	RESPANEL-013	14	16
305	2/0 (2x)	N/A	RESPANEL-013	14	16
365	3/0 (2x)	N/A	RESPANEL-013	14	16
415	4/0 (2x)	N/A	RESPANEL-013	14	16
515	300kcmil (2x)	N/A	RESPANEL-014	14	16
600	350kcmil(2x)	N/A	RESPANEL-014	14	16

Note: To prevent flexing or bending of the coil windings attached to dV Sentry filter, use appropriate strain relief to prevent stress on terminals. For flat copper terminal tabs, use two wrenches to tighten customer provided cable mounting hardware.

Note: Refer to reference drawings on MTE website for termination wire ranges:

www.mtecorp.com/dv-sentry-literature-documents/

5. START UP

Startup Checklist

Safety Precautions

Before startup, observe the following warnings and instructions:

 WARNING	Internal components of the filter are at line potential when the filter is connected to the drive. This voltage is extremely dangerous and may cause death or severe injury if you come in contact with it.
	Use extreme caution to avoid contact with line voltage when checking for power. INJURY OR DEATH MAY RESULT IF SAFETY PRECAUTIONS ARE NOT OBSERVED.
	Damage to equipment may occur if the drive startup procedures are not observed.
	Damage to the filter may occur if the appropriate output carrier frequency is not observed.

Sequence of Operation

1. Read and follow safety precautions.
2. After installation, ensure that:
 - All filter ground terminals are connected to ground.
 - Power wiring to the utility, drive, filter and motor is in accordance with the power wiring connection diagrams shown in installation instructions section.
3. Check that moisture has not condensed on the filter components. If moisture is present, do not proceed with startup until the moisture has been removed.
4. Disconnect filter output terminals from the motor.
5. Set the drive switching frequency to the appropriate setting.
 - 2kHz – 10kHz (3A – 110A Filters)
 - 2kHz – 5kHz (130A – 600A Filters)
6. Connect filter temperature safety overload switch into the control circuit so that the drive will shut down in an overload situation.
7. Confirm that drive voltage is present at the input terminals (U1, V1, W1) of the filter.
8. Confirm that drive voltage is present at the output terminals (U2, V2, W2) of the filter.
9. Connect the filter output to the motor.
10. Refer to the drive user manual for the drive startup procedure. Observe all safety instructions in the drive user manual.

6. TROUBLESHOOTING

 WARNING	<p>INJURY OR DEATH MAY RESULT IF THE DRIVE SAFETY PRECAUTIONS ARE NOT OBSERVED.</p>
	<p>When properly installed, this equipment has been designed to provide maximum safety for operating personnel. However, hazardous voltages and elevated temperatures exist within the confines of the enclosure. Servicing should therefore be performed by qualified personnel only and in accordance with OSHA Regulations.</p>
	<p>High voltage is used in the operation of this filter. Use Extreme caution to avoid contact with high voltage when operating, installing or repairing this filter. INJURY OR DEATH MAY RESULT IF SAFETY PRECAUTIONS ARE NOT OBSERVED.</p>

To aid in troubleshooting, two interconnection diagrams and a troubleshooting guide that lists potential problems and solutions are included:

Figure 4-2: Panel Mounted and Enclosed Diagram (p11)

Figure 4-3: Open Panel Diagram (p12)

Table 6-2: Troubleshooting Guide (p16)

For specific product performance specifications, reference Table 6-1 below:

Table 6-1: Performance Specifications

Voltage	208V - 600V +/- 10%; 60Hz
Inverter Operating Frequency	0 – 90Hz without derating
Maximum Ambient Temperature	-40C to +60C Modular Filter -40C to +50C Enclosed Filter
Insulation System	Class N (200° C)
Insertion Loss (Voltage)	1.7% @ 60Hz; 2.6% @ 90Hz
Efficiency	>99%
Altitude without derating	3,300 feet above sea level
Maximum Motor Lead Length	1,000 feet
Relative Humidity	0% to 99% non-condensing
Current Rating	100% RMS Continuous; 150% for 1 minute; 200% for 10 sec *Operating in overload will result in increased proportional voltage drop
Rise Time	Less than 0.1 uS
Peak Voltage @ Motor	150% of DC bus voltage up to 1,000 feet
Common Mode Reduction	50%+ Peak current reduction typical

Table 6-2: Troubleshooting Guide

PROBLEM: Voltage is not present at the filter input terminals.	
Possible cause:	Power to the filter is turned off or shut down.
Solution:	Turn power on; check drive errors.
Possible cause:	One or more external line fuses are blown.
Solution:	Verify the continuity of line fuses in all phases. Replace as necessary.
Possible cause:	Damage to drive – dV Sentry interconnect cables.
Solution:	Replace damaged cables.
Possible cause:	Drive setup parameters are incorrect.
Solution:	Verify motor current, voltage, and shutdown parameters are valid.
PROBLEM: dV Sentry filter runs Hot	
Possible cause:	Normal operation, reactor > 150° C and resistors > 300° C.
Solution:	Caution: Parts are very hot and may cause burns. Follow installation guidelines for clearance and check for adequate air flow.
Possible cause:	Motor coil damage; windings shorted.
Solution:	Replace motor; inspect wiring.
Possible cause:	Heat buildup within enclosure.
Solution	Provide clearance and venting for filter components.
Possible cause:	Heat buildup within enclosure.
Solution	Check carrier frequency and overload settings.
Possible cause:	Multiple motor applications create complex loading and resonances with dV Sentry filter.
Solution:	Use only one dV Sentry filter per drive for a single motor. For multiple line applications, use a sine wave filter.